

# Wiringkit

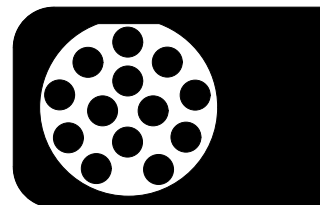

D	Einbauanleitung
GB	Installation instructions
F	Consignes de montage
NL	Montagehandleiding
DK	Montagevejledning
N	Monteringsinstruksjon
S	Installationsanvisning
FIN	Asennusohje
I	Istruzioni per il montaggio
E	Instrucciones de montaje
P	Instruções de montagem
GR	Οδηγίες εγκατάστασης
CZ	Návod k montáži
SLO	Navodilo za vgradnjo
SK	Montážny návod
PL	Instrukcja montażu
TR	Montaj talimatı
H	Beépítési útmutató
HR	Upute o ugradnji
BUL	Инструкция за монтаж
RO	Instrucțiuni de montaj
RU	Инструкция по монтажу и установке
LT	Montavimo informacija
LV	Iemontēšanas pamācība
EST	Paigaldusjuhend

## 756594 VOLKSWAGEN

- **Caddy 3 & 4 Kombi/Kasten** 02/04 >> 08/20
- **Caddy 3 Life** 02/04 >> 04/15
- **Caddy 3 & 4 Maxi** 01/08 >> 08/20
- **Caddy 3 & 4 Cross** 06/13 >> 08/20
- **Caddy 4 EcoProfi** 05/15 >> 08/20

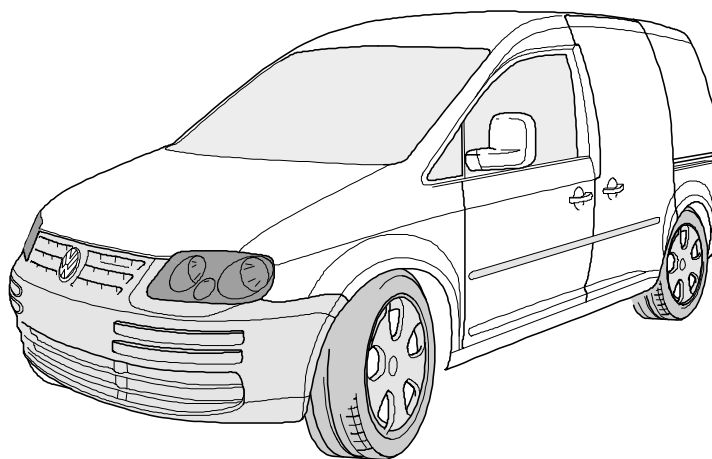

# OVERVIEW

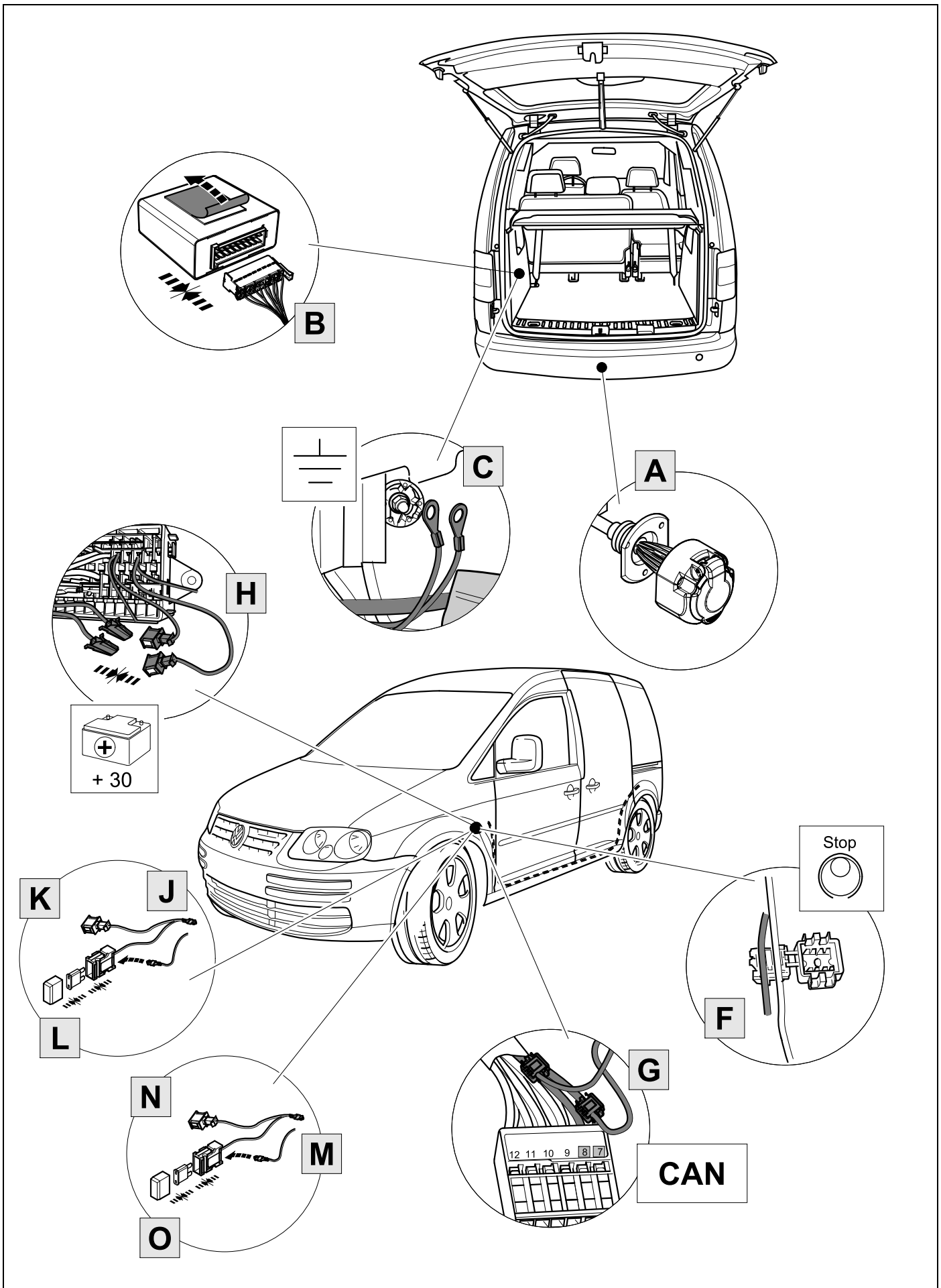

# KIT

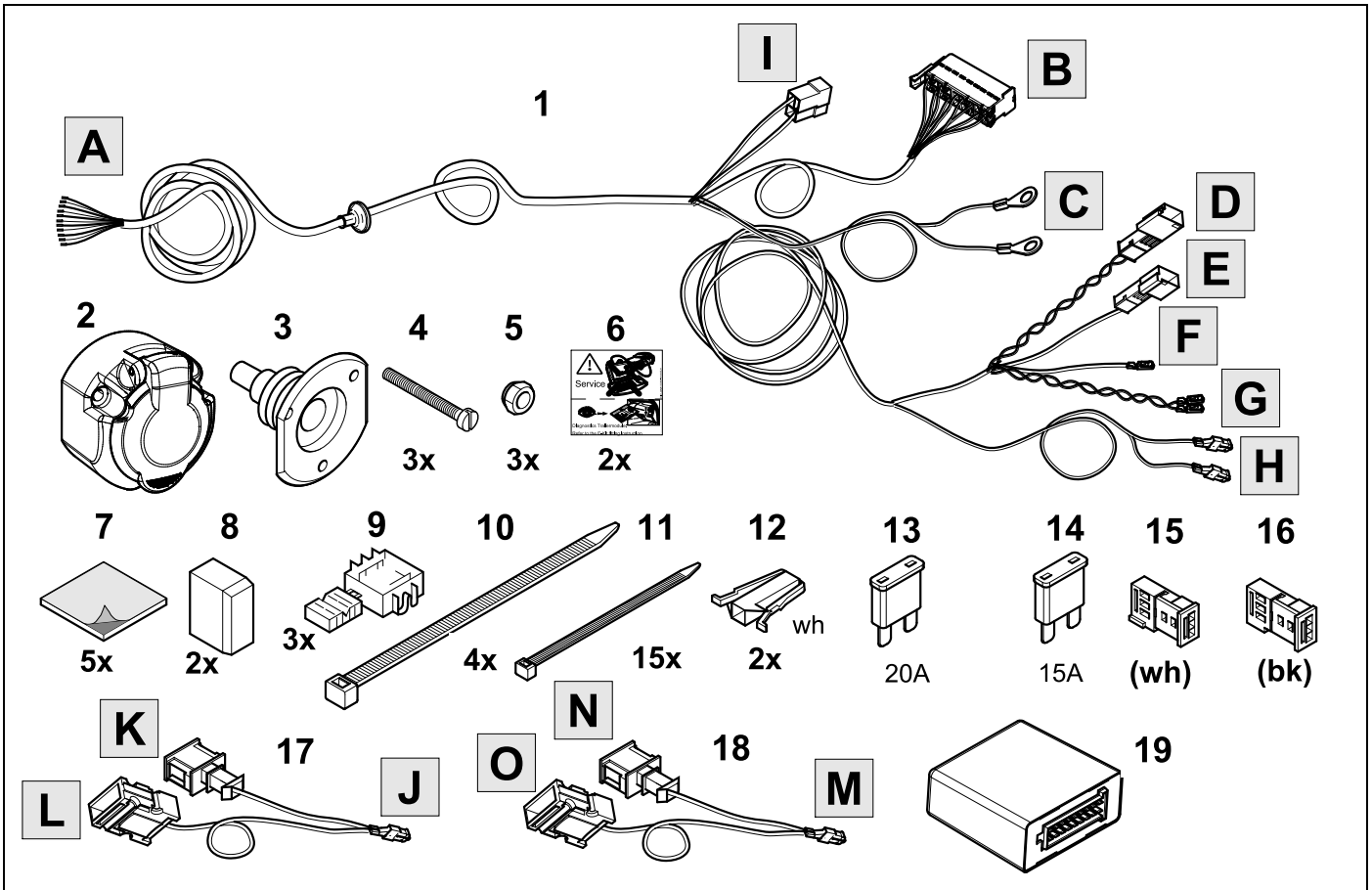

# TOOLS

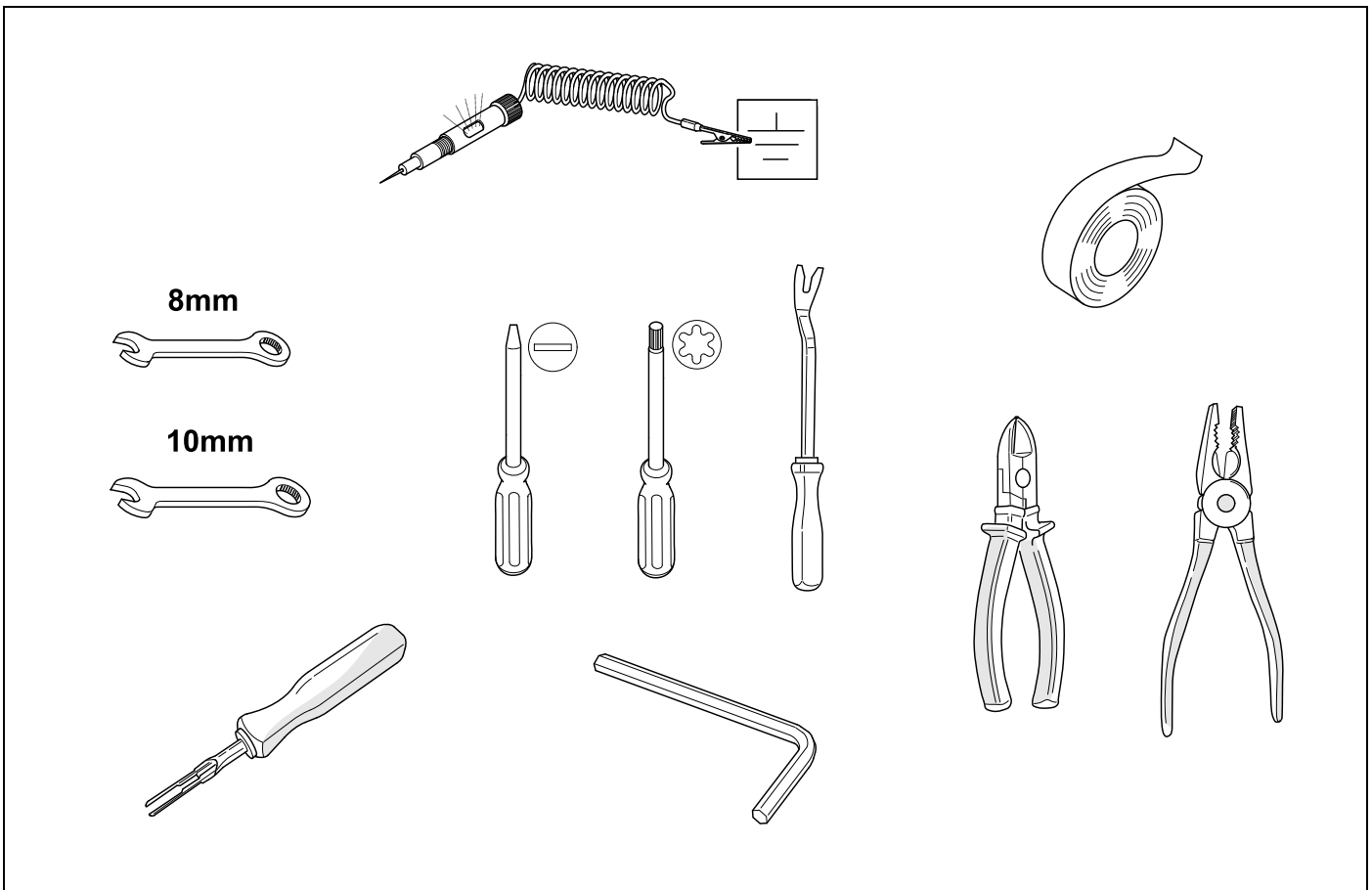



# 3 ROUTING

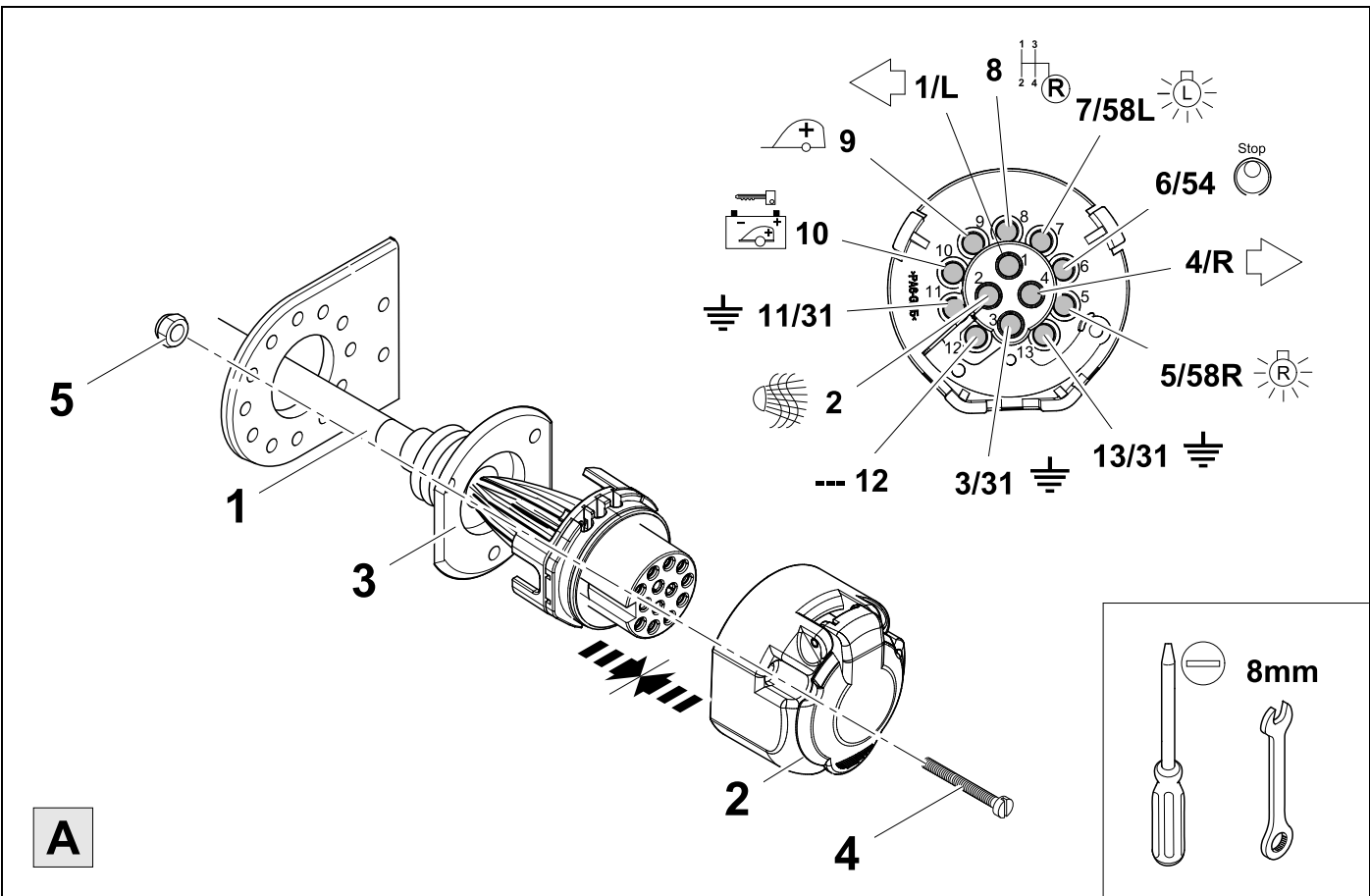
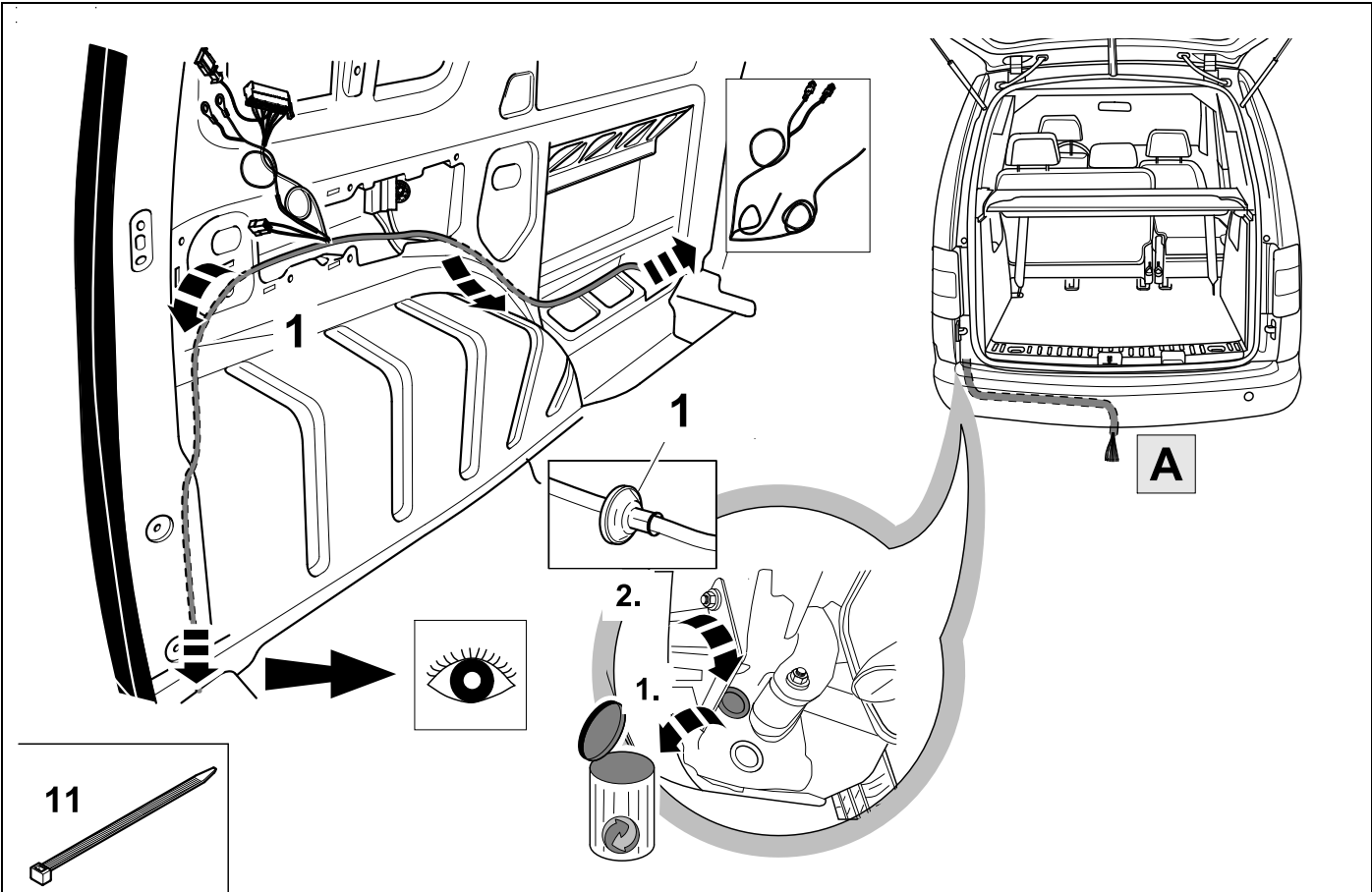

5



6

13-pin			13-pin		
1	bk/wh		8	bu/rd	
2	gy		9	rd/bu	
3	wh/bn		10	ye	
4	bk/gn		11	bn/gn	
5	gy/rd		12	no	-/-
6	bk/rd		13	bn	
7	gy/bk				

6	bk	wh	gy	gn	rd	bu	ye	bn	pu	or	no
(D)	schwarz	weiss	grau	grün	rot	blau	gelb	braun	violett	orange	nicht belegt
(GB)	black	white	grey	green	red	blue	yellow	brown	purple	orange	not occupied
(F)	noir	blanc	gris	vert	rouge	bleu	jaune	brun	violet	orange	inutilisé
(NL)	zwart	wit	grijs	groen	rood	blauw	geel	bruin	violet	oranje	niet aangesloten
(DK)	sort	hvid	grå	grøn	rød	blå	gul	brun	violet	orange	ikke anvendt
(N)	svart	hvit	grå	grønn	rød	blå	gul	brun	fiolett	oransje	ikke i bruk
(S)	svart	vit	grå	grön	röd	blå	gul	brun	violett	orange	ej använd
(FIN)	musta	valkoinen	harmaa	vihreä	punainen	sininen	keltainen	ruskea	violetti	oranssi	ei varattu
(I)	nero	bianco	grigio	verde	rosso	blu	giallo	marrone	viola	arancione	libero
(E)	negro	blanco	gris	verde	rojo	azul	amarillo	marrón	violeta	anaranja-do	no ocupado
(P)	preto	branco	cinzento	verde	vermelho	azul	amarelo	castanho	violeta	laranja	não ocupado
(GR)	μαύρος	λευκός	Γκρι	πράσινος	κόκκινος	μπλε	κίτρινος	καφέ	Μωβ	πορτοκαλί	δεν είναι κατ'επιλογή
(CZ)	černý	bílý	šedý	zelený	červený	modrý	žlutý	hnědý	fialový	oranžový	neo-bsazen
(TR)	siyah	beyaz	gri	yeşil	kırmızı	mavi	sarı	kahverengi	mor	portakal rengi	boş
(H)	fekete	fehér	szürke	zöld	piros	kék	sárga	barna	ibolyakék	narancssárga	nem foglalt
(HR)	crno	bijelo	sivo	zeleno	crveno	plavo	zuto	smeđe	ljubičasto	narandasto	nije zauzeto
(BUL)	черен	бял	сив	зелен	червен	син	жълт	кафяв	виолетов	оранжев	свободно
(RO)	negru	alb	gri	verde	roșu	albastru	galben	maro	violet	portocaliu	liber
(RU)	черный	белый	серый	зеленый	красный	голубой	жёлтый	коричневый	пурпурный	оранжевый	свободно
(LT)	juoda	balta	pilka	žalia	raudona	mėlyna	geltona	ruda	purpurinė	oranžinė	laisva
(LV)	melna	balta	pelēka	zaļa	sarkana	zila	dzeltena	brūna	purpur-sarkana	oranža	brīvs
(EST)	must	valge	hall	roheline	punane	sinine	kollane	pruun	purpur-punane	oraanz	vaba
(SLO)	črna	bela	siva	zelena	rdeča	modra	rumena	smeđ	vijoličast	oranžen	ni zasedeno
(SK)	čierny	biely	šedý	zelený	červený	modrý	žltý	hnedý	fialový	pomarančový	neo-sadený

7

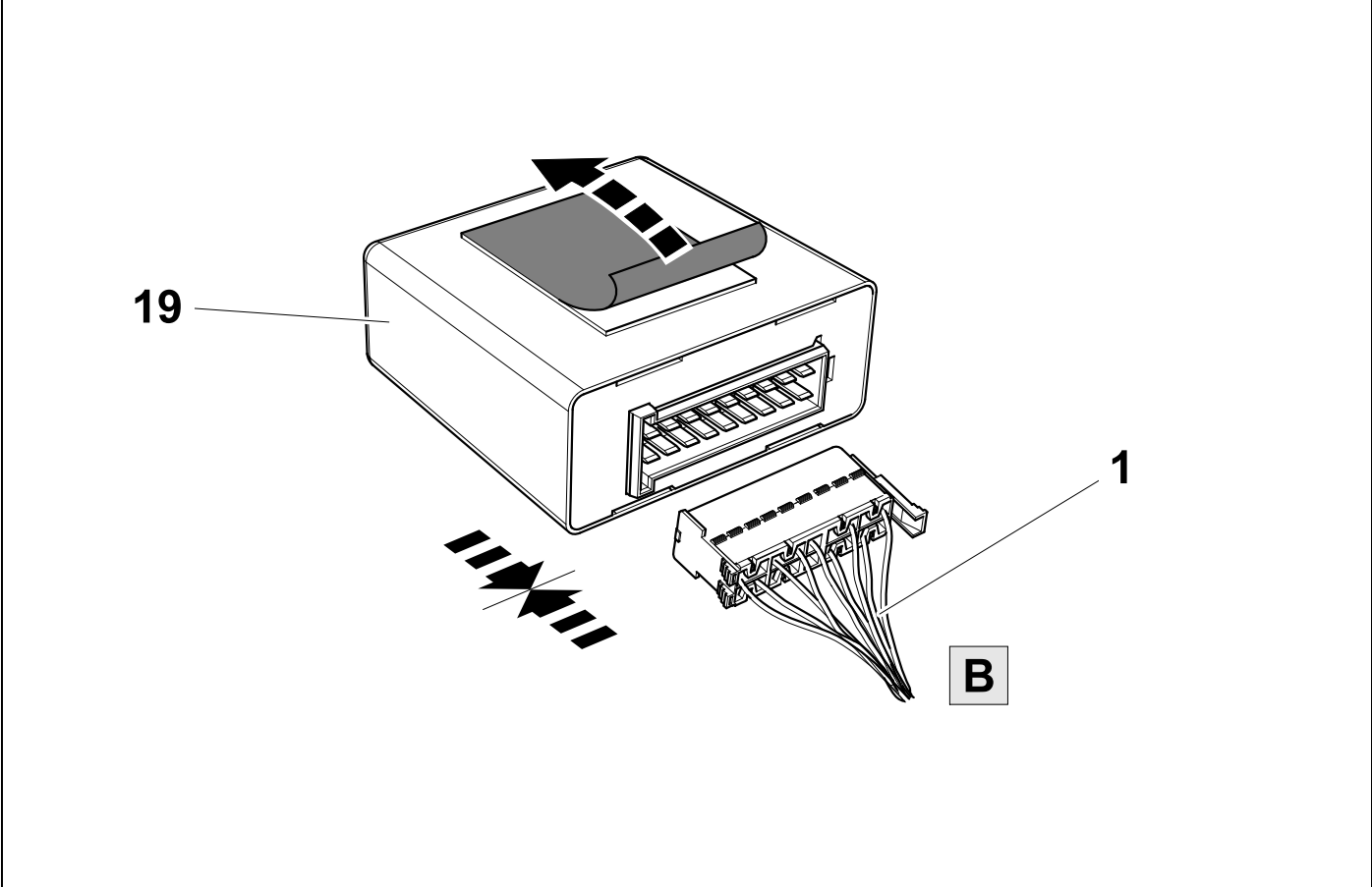

8

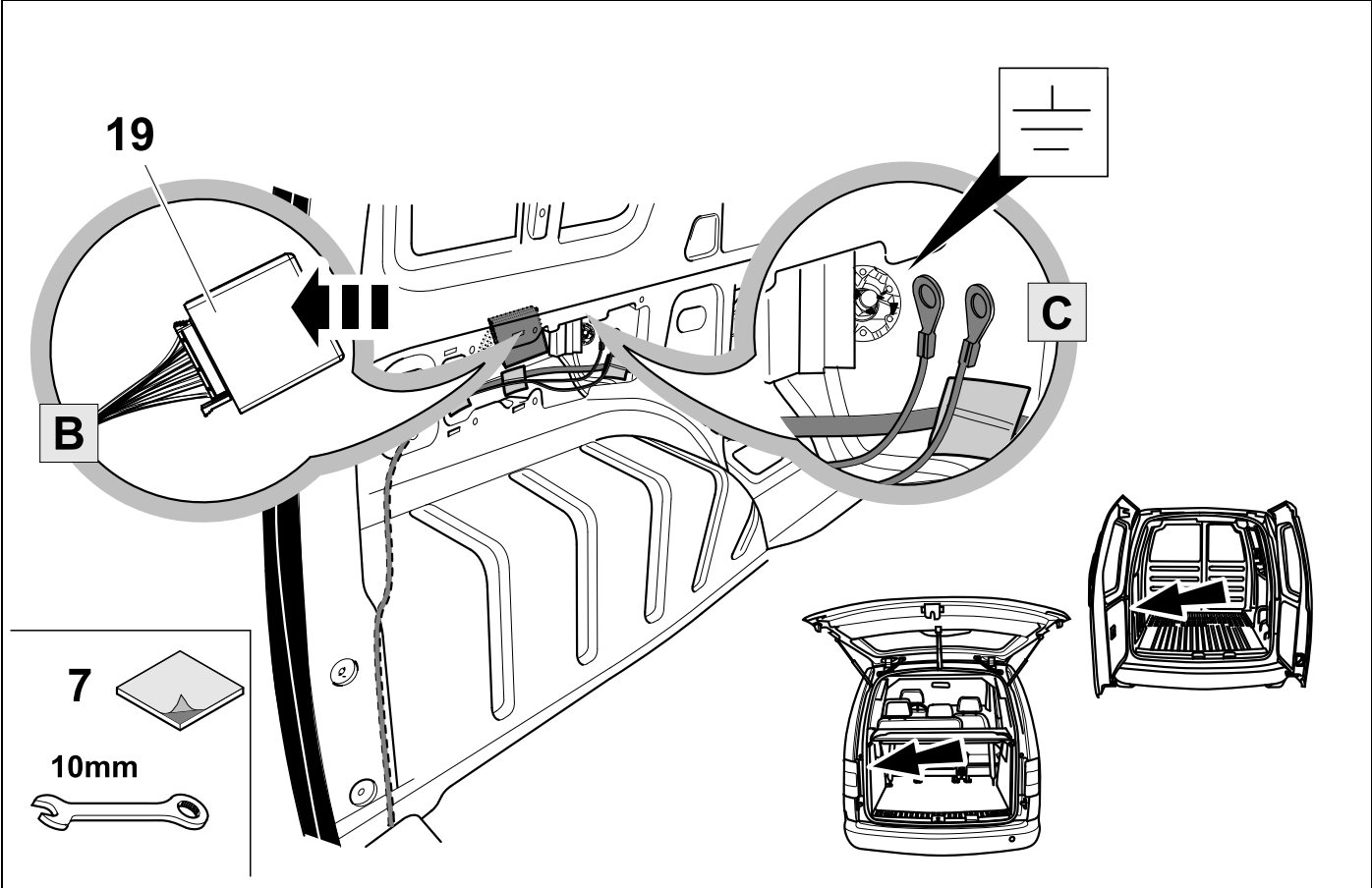

9

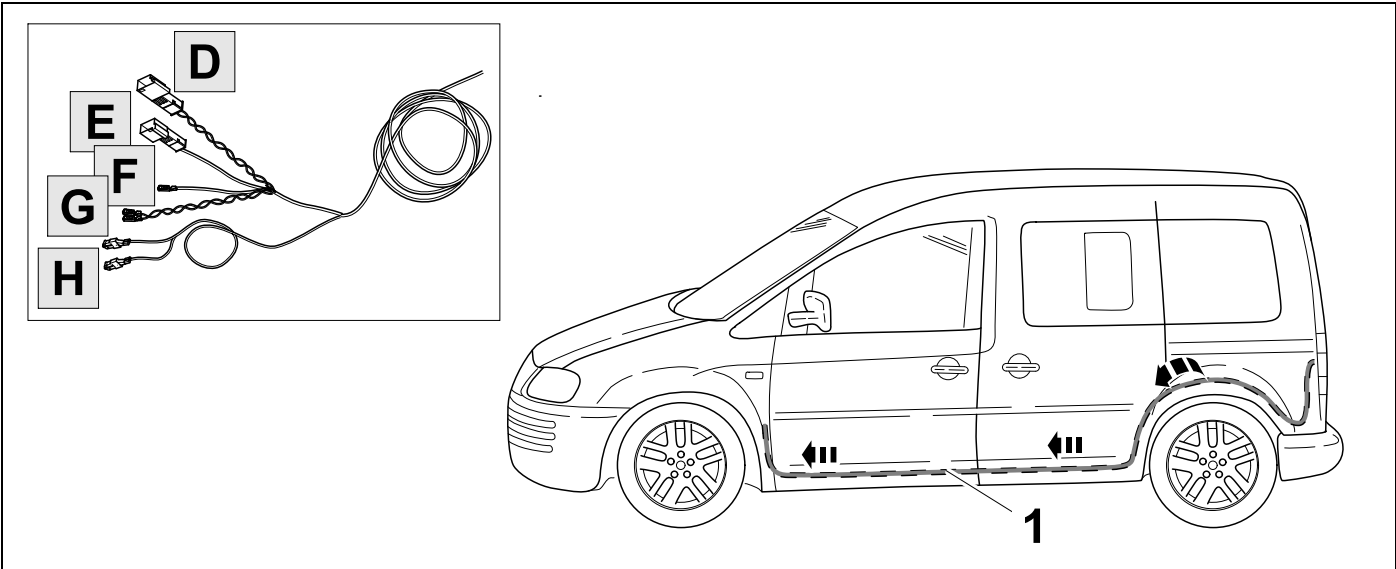

10

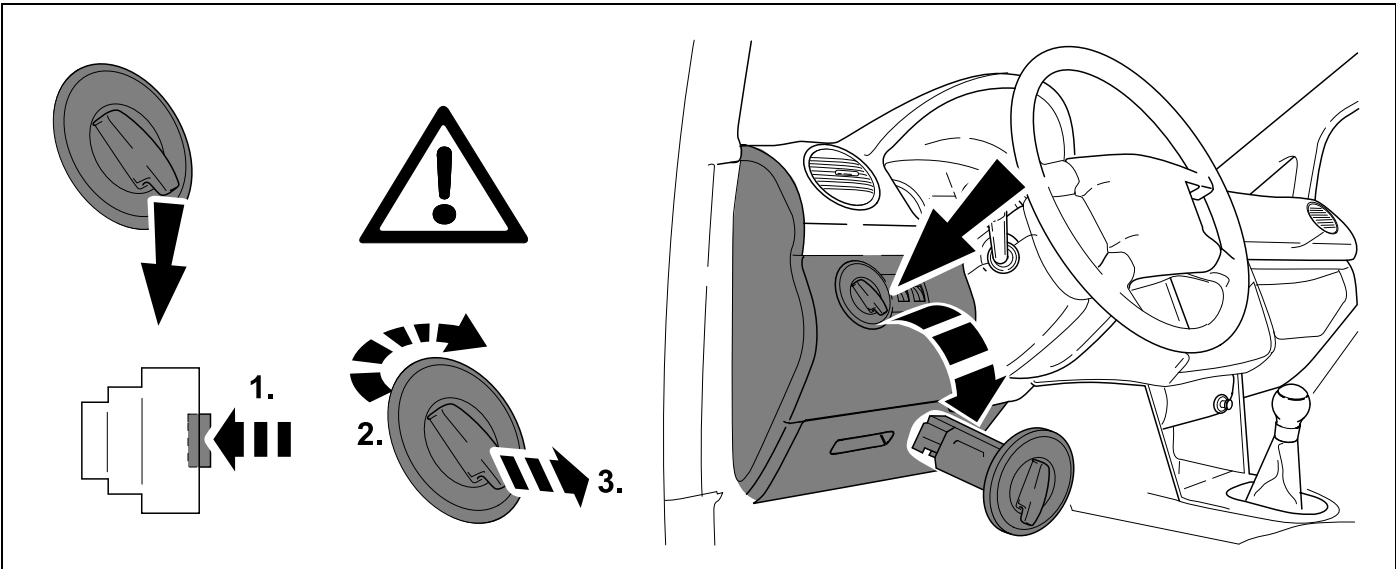

11

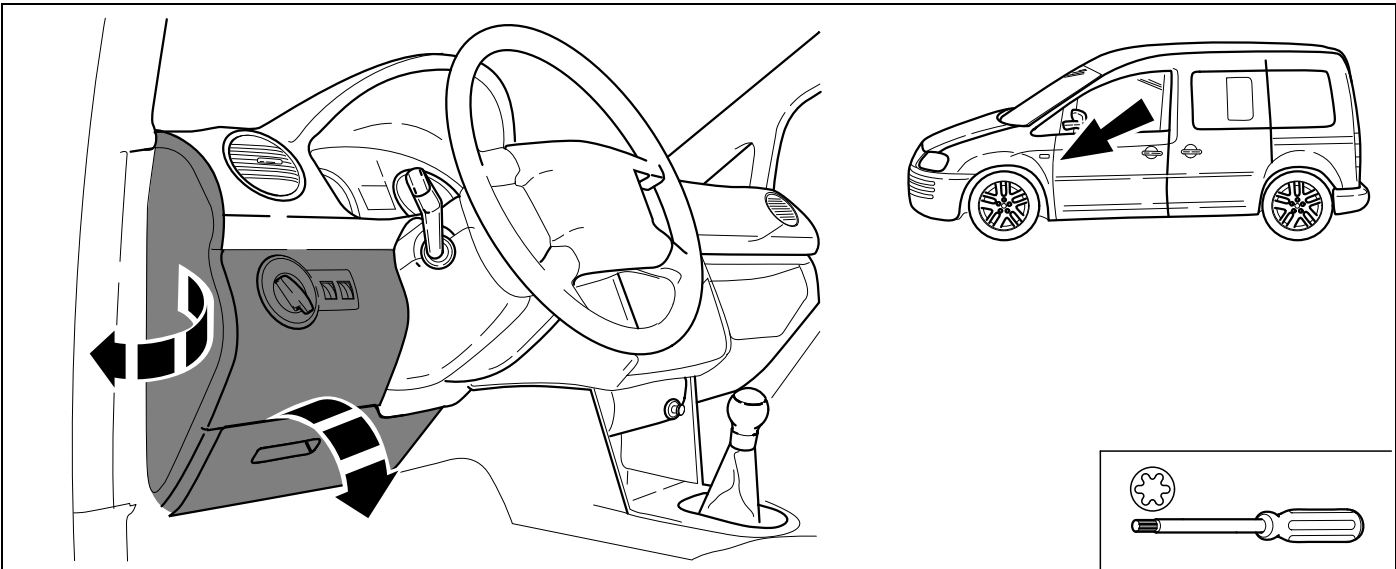



12

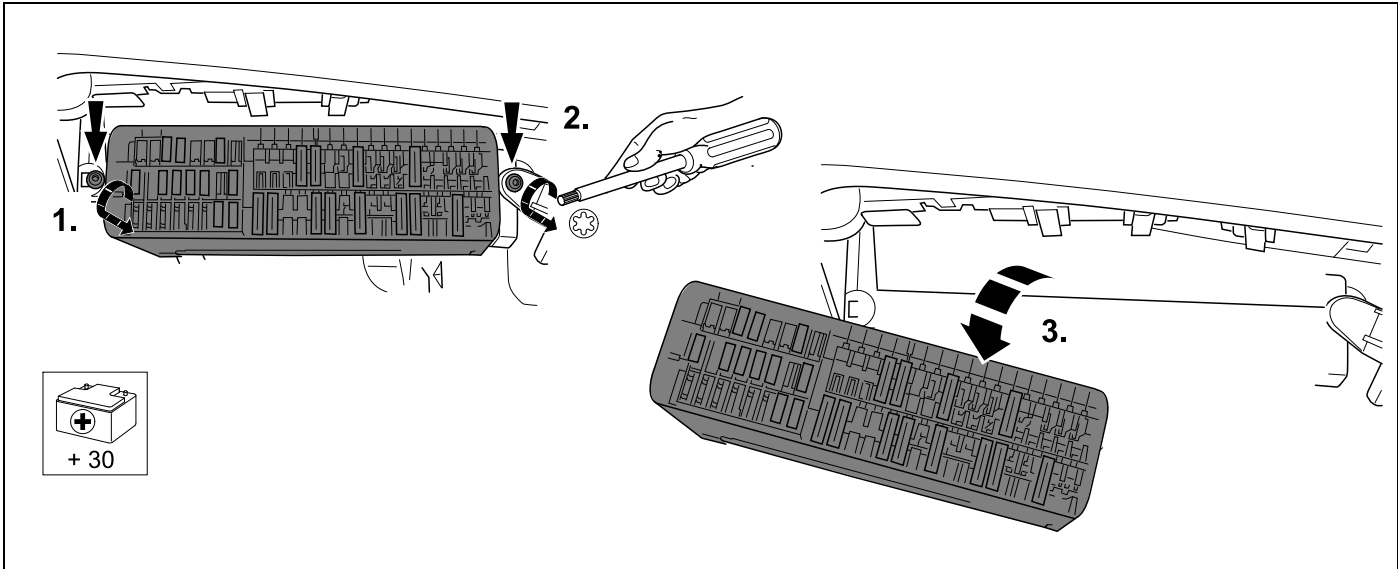

13

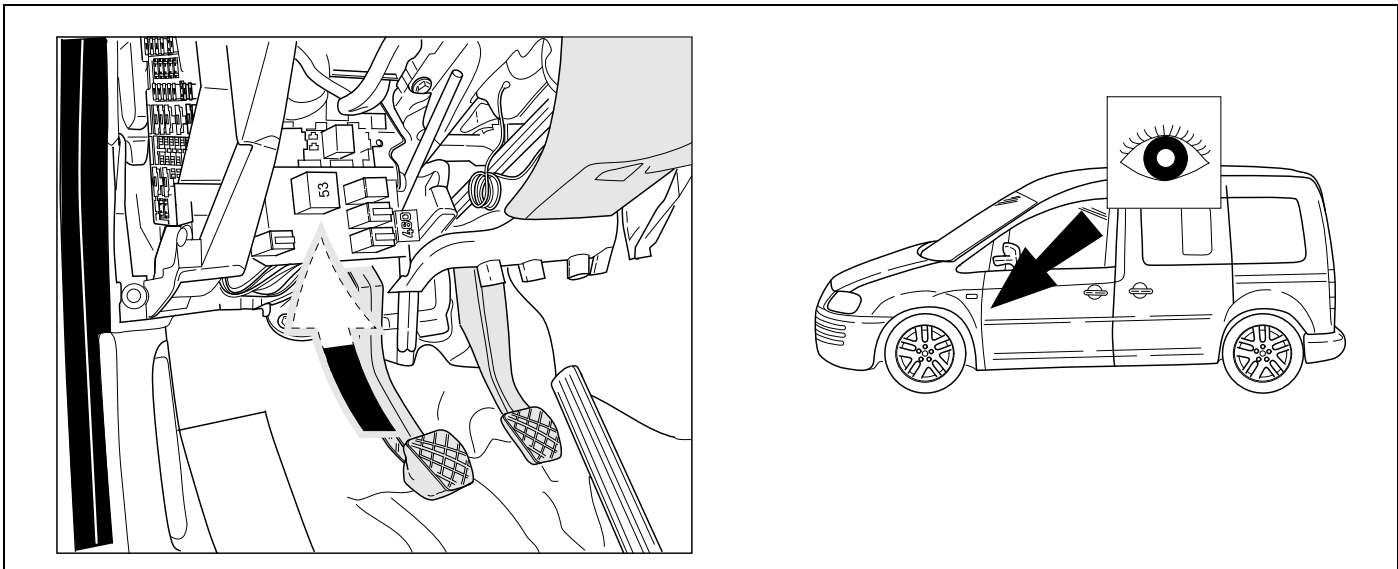

**Caddy Kombi/Kasten**      **02/04 →**

**16** - **29**

**Caddy Life**      **07/04 → 04/15**

+

**38** - **65**

**Caddy Maxi**      **01/08 →**

**Caddy Kombi/Kasten**      **02/04 →**

**Caddy Life**      **07/04 → 04/15**

**30** - **65**

**Caddy Maxi**      **01/08 →**  
**Caddy EcoProfi**      **05/15 →**

**Caddy Cross**      **06/13 →**

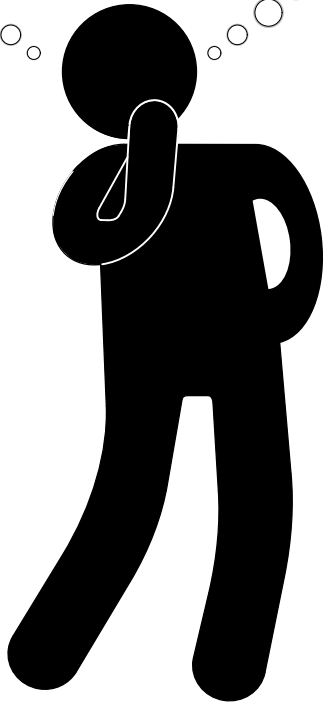
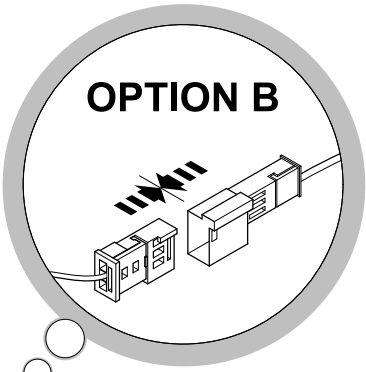
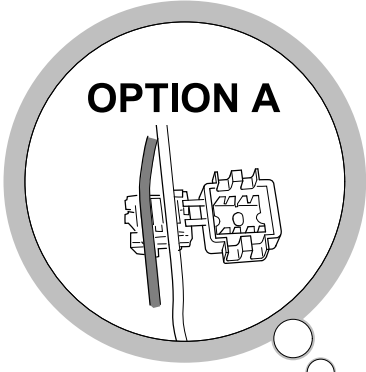

**OPTION A**

$$\begin{array}{r} \boxed{17} - \boxed{24} \\ + \\ \boxed{38} - \boxed{65} \end{array}$$

**OPTION B**

$$\begin{array}{r} \boxed{17} \\ + \\ \boxed{25} - \boxed{29} \\ + \\ \boxed{38} - \boxed{65} \end{array}$$

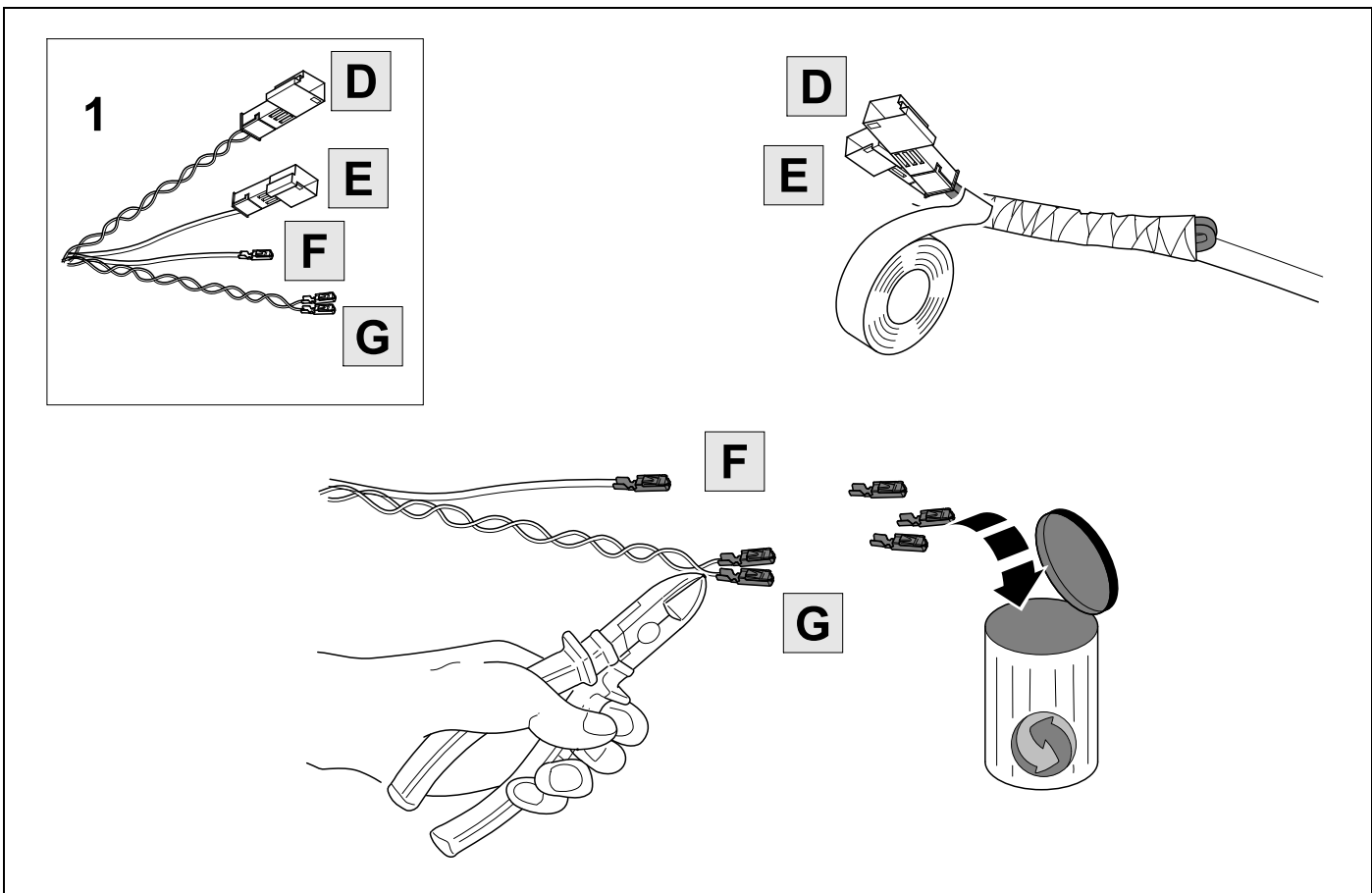
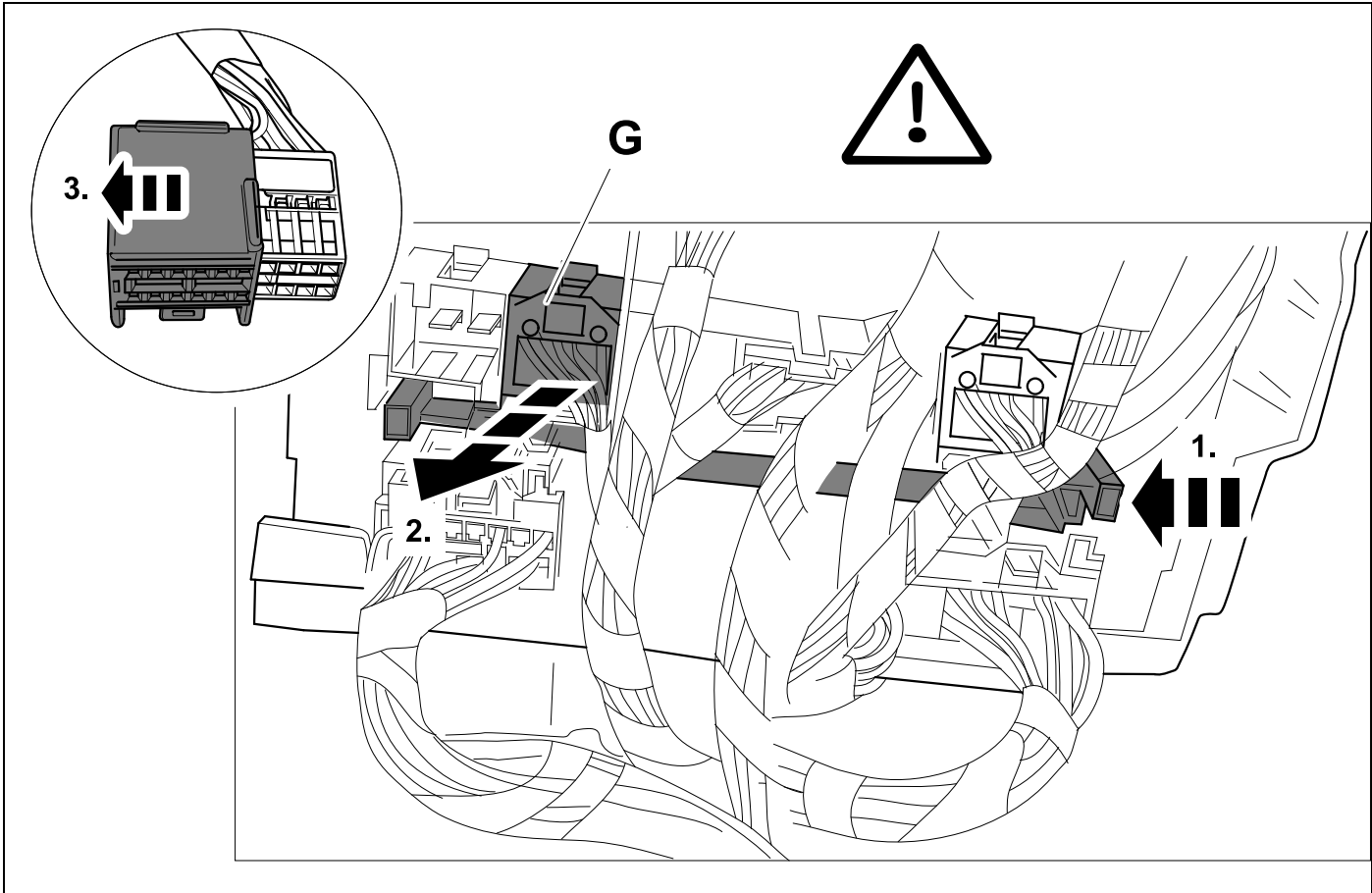

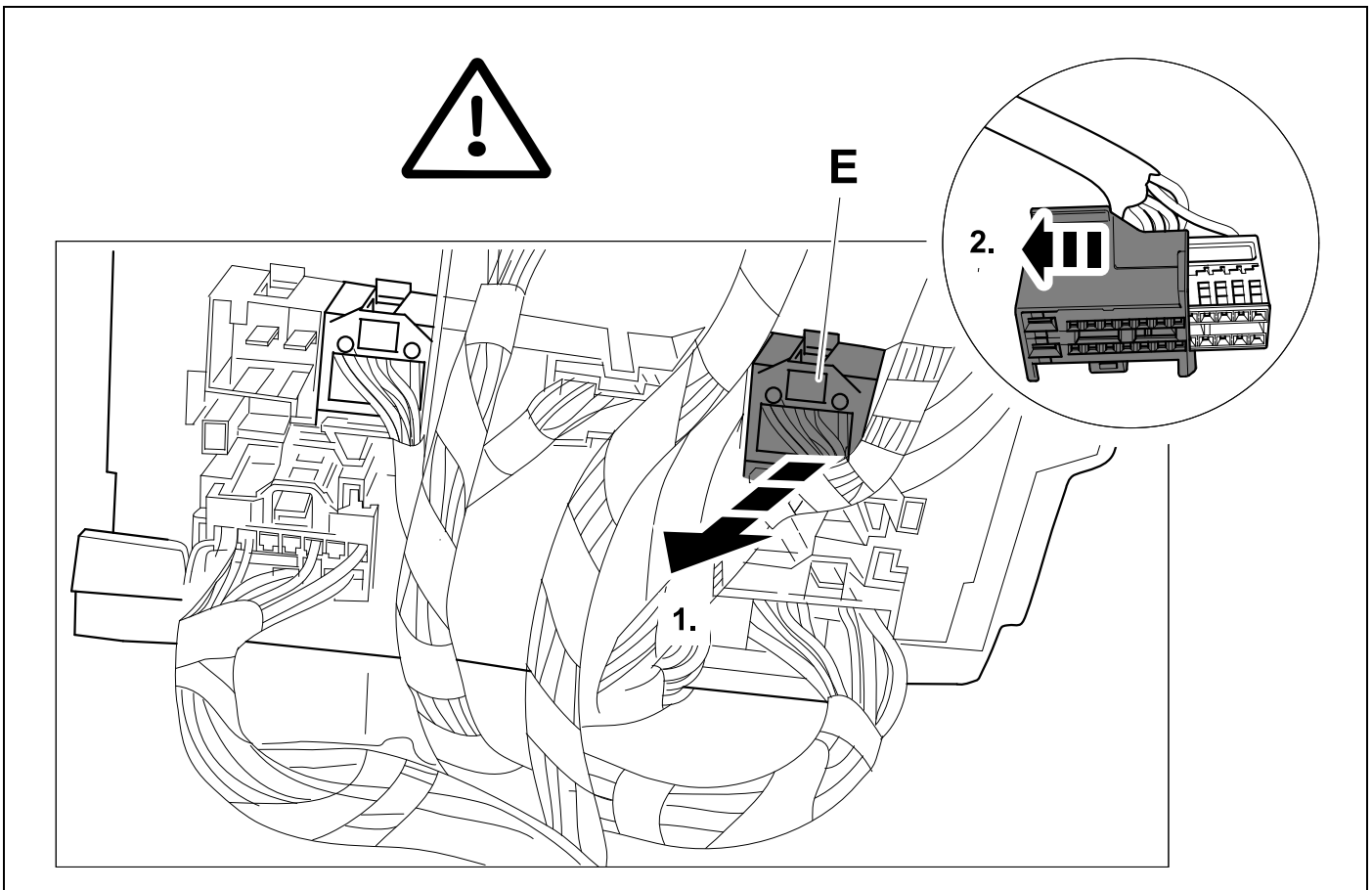
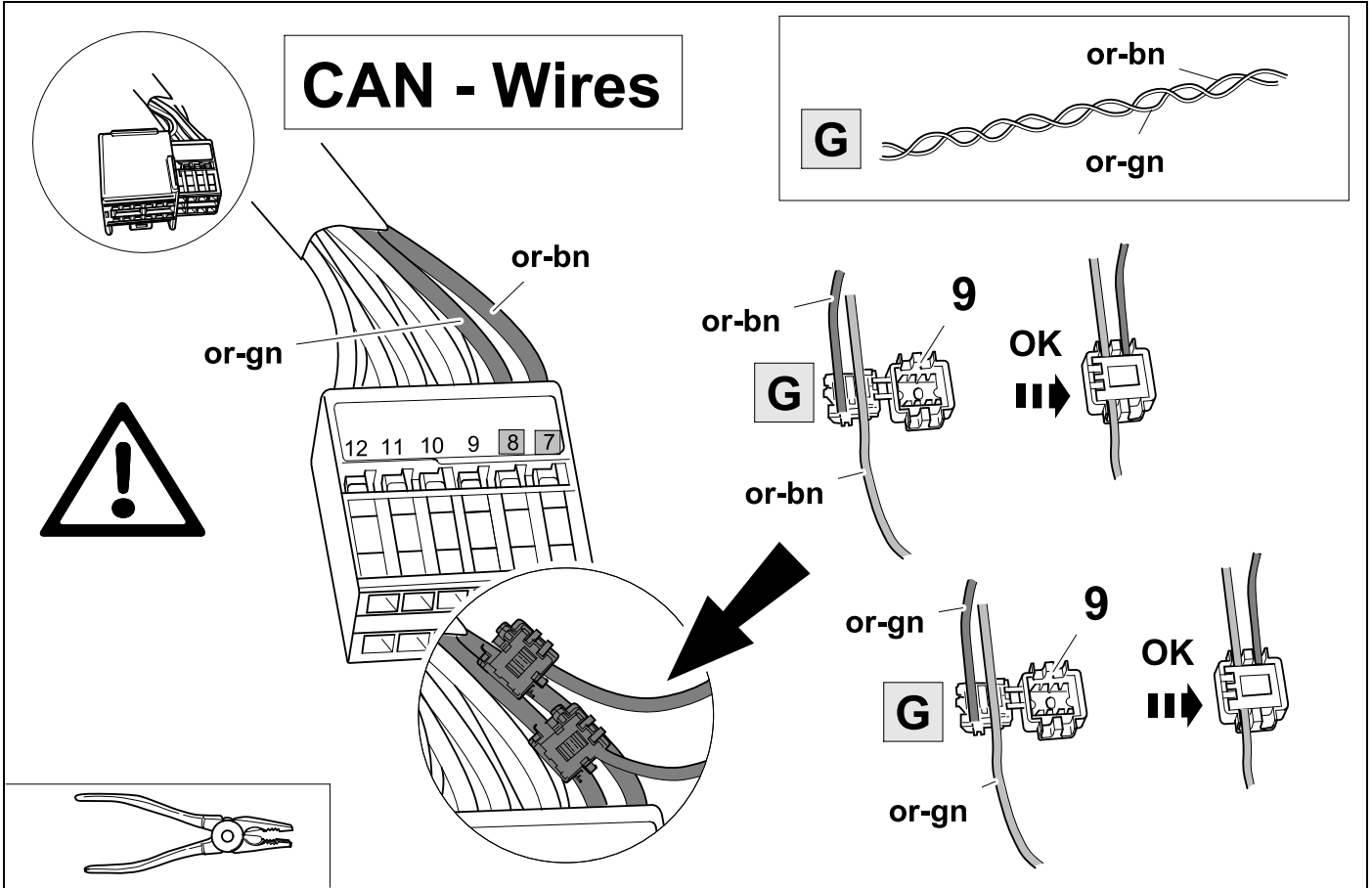

21 OPTION A



6

→ 2009

**PIN 2** → **rd-bk / ye-bk**

**OPTION A.1**  
22

**PIN 2** → **no**

**OPTION A.2**  
23

**OPTION A.3**  
24

Stop

22 OPTION A.1



6

→ 2009

**rd-bk / ye-bk**

**rd-ye**

**OK**

**9**

**F**

**rd-ye**

**F**

Stop

23 OPTION A.2



6

→ 2009

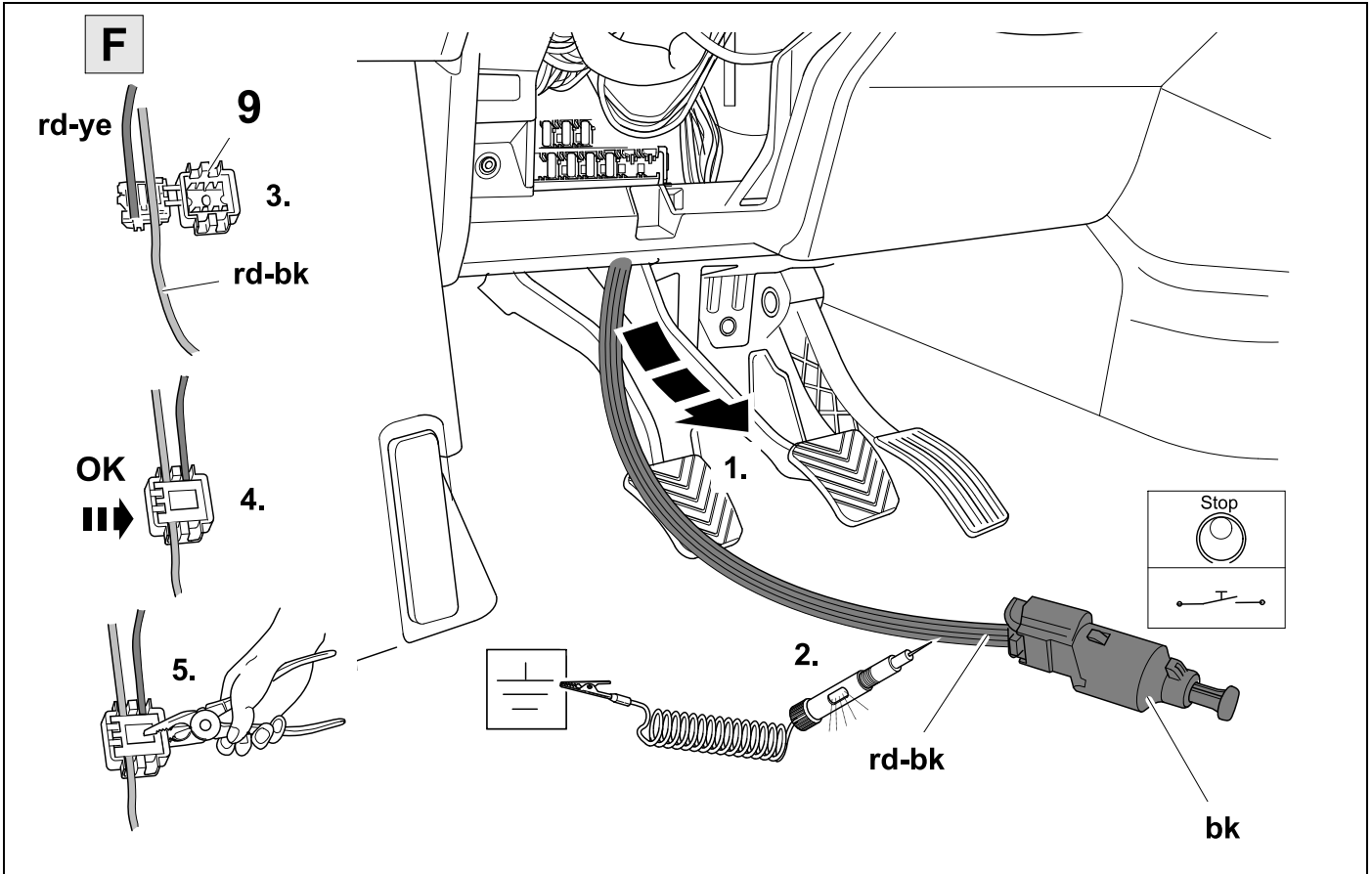

24 OPTION A.3



6

→ 2009

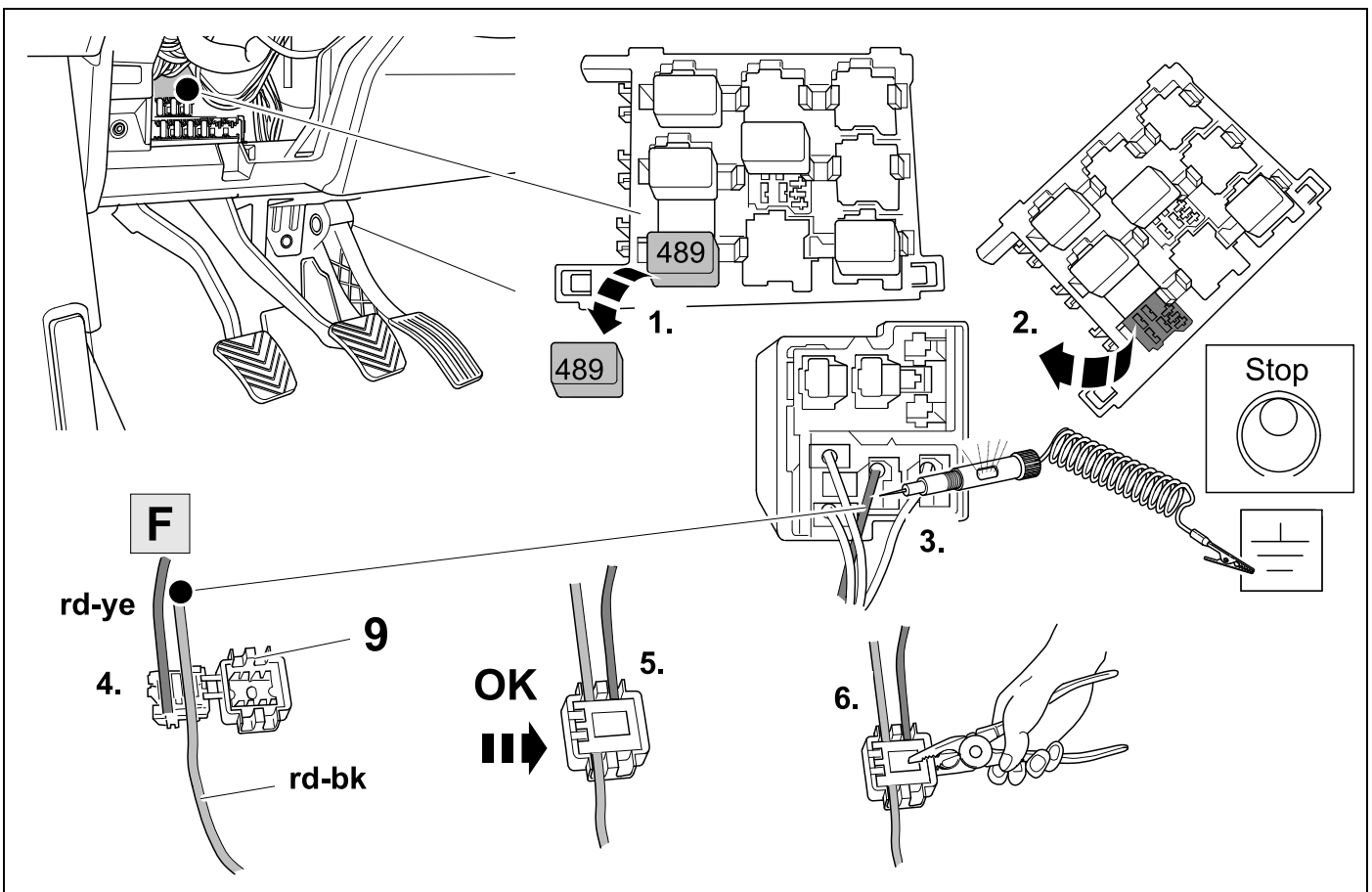



# CAN - Wire

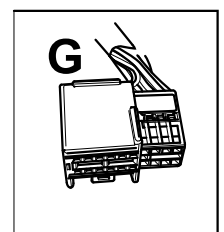
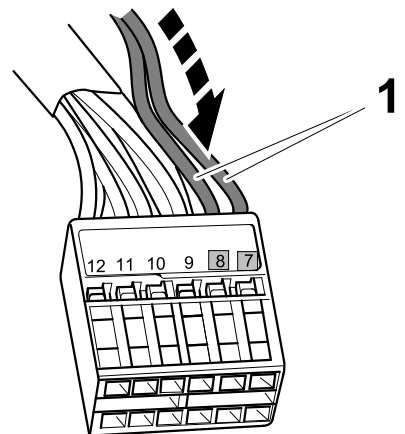
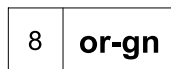
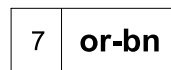
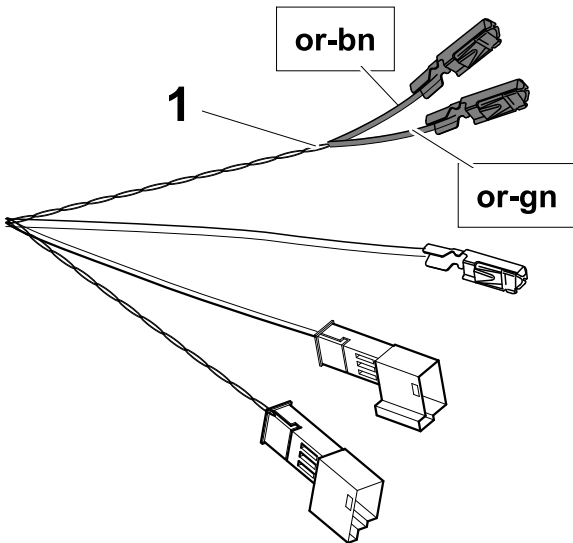
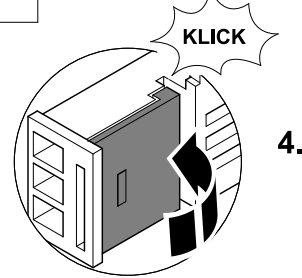
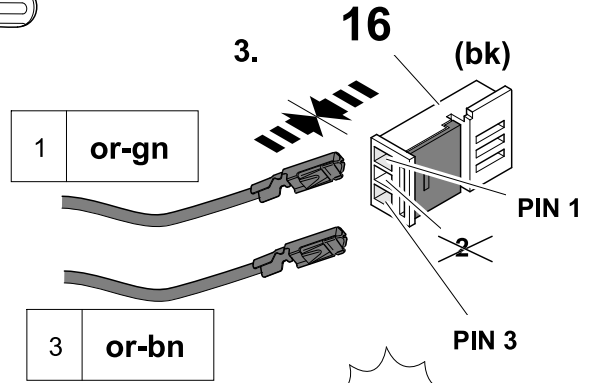
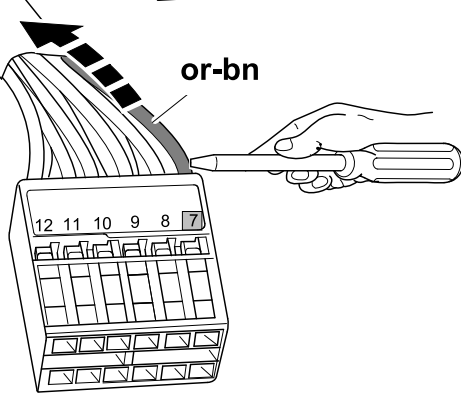
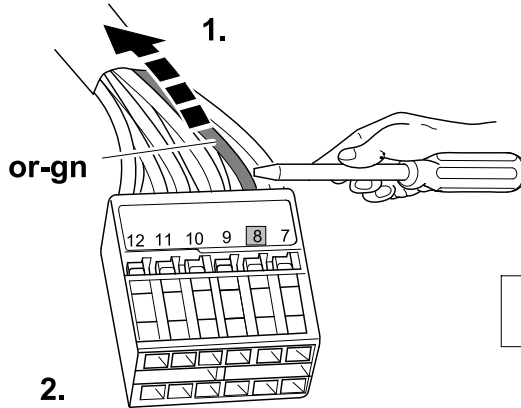
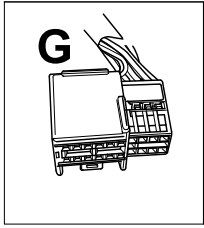



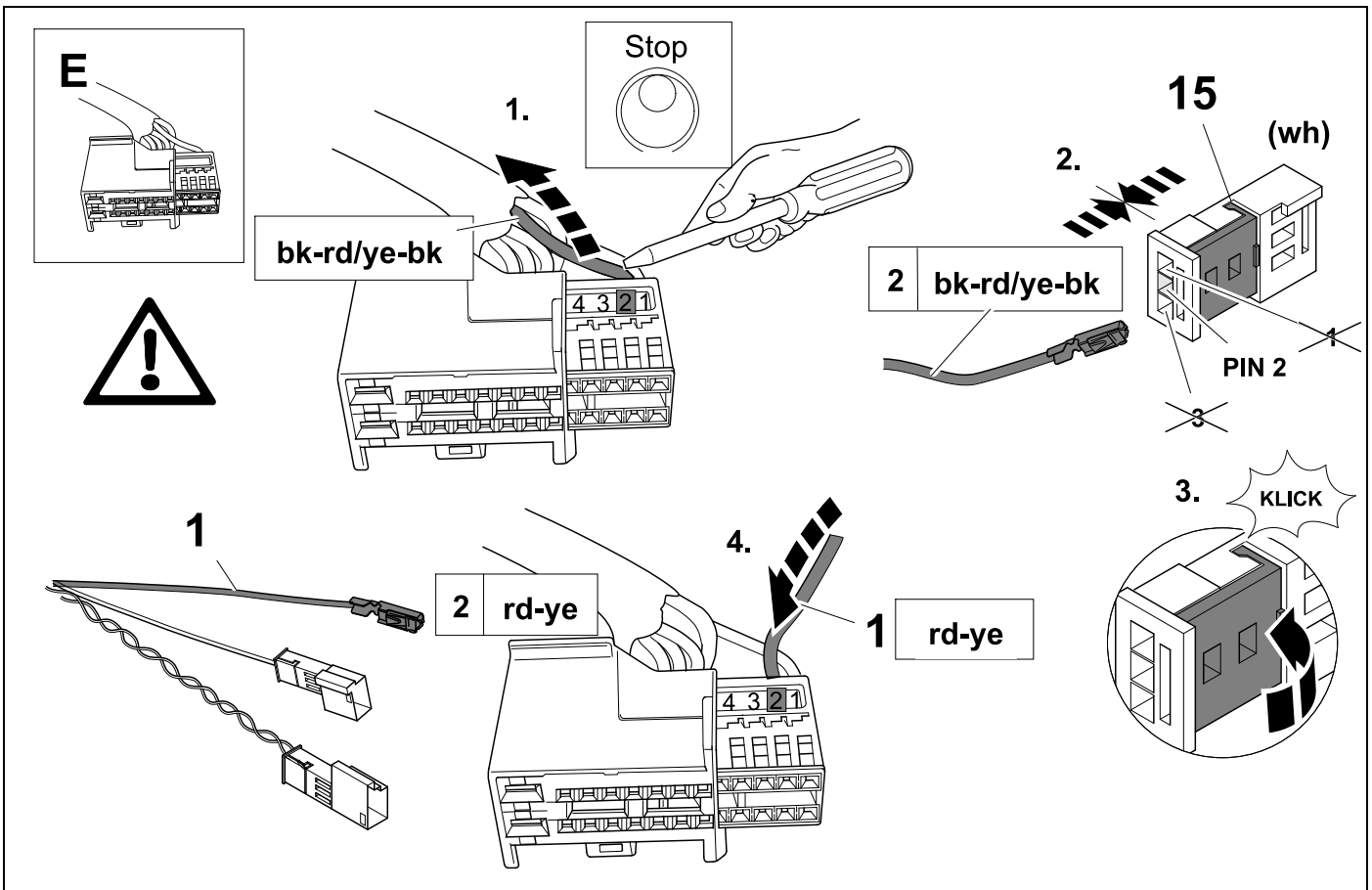
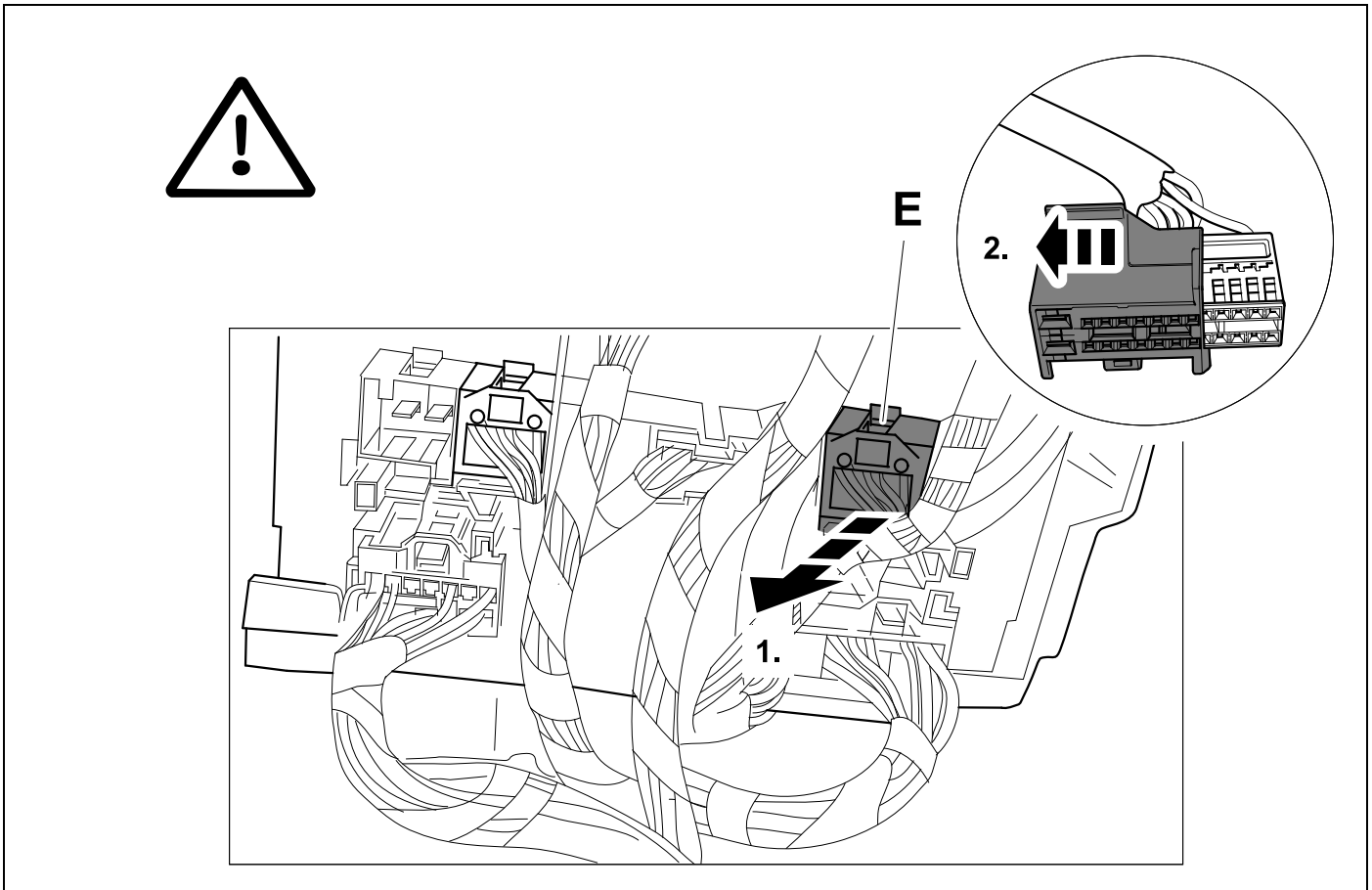

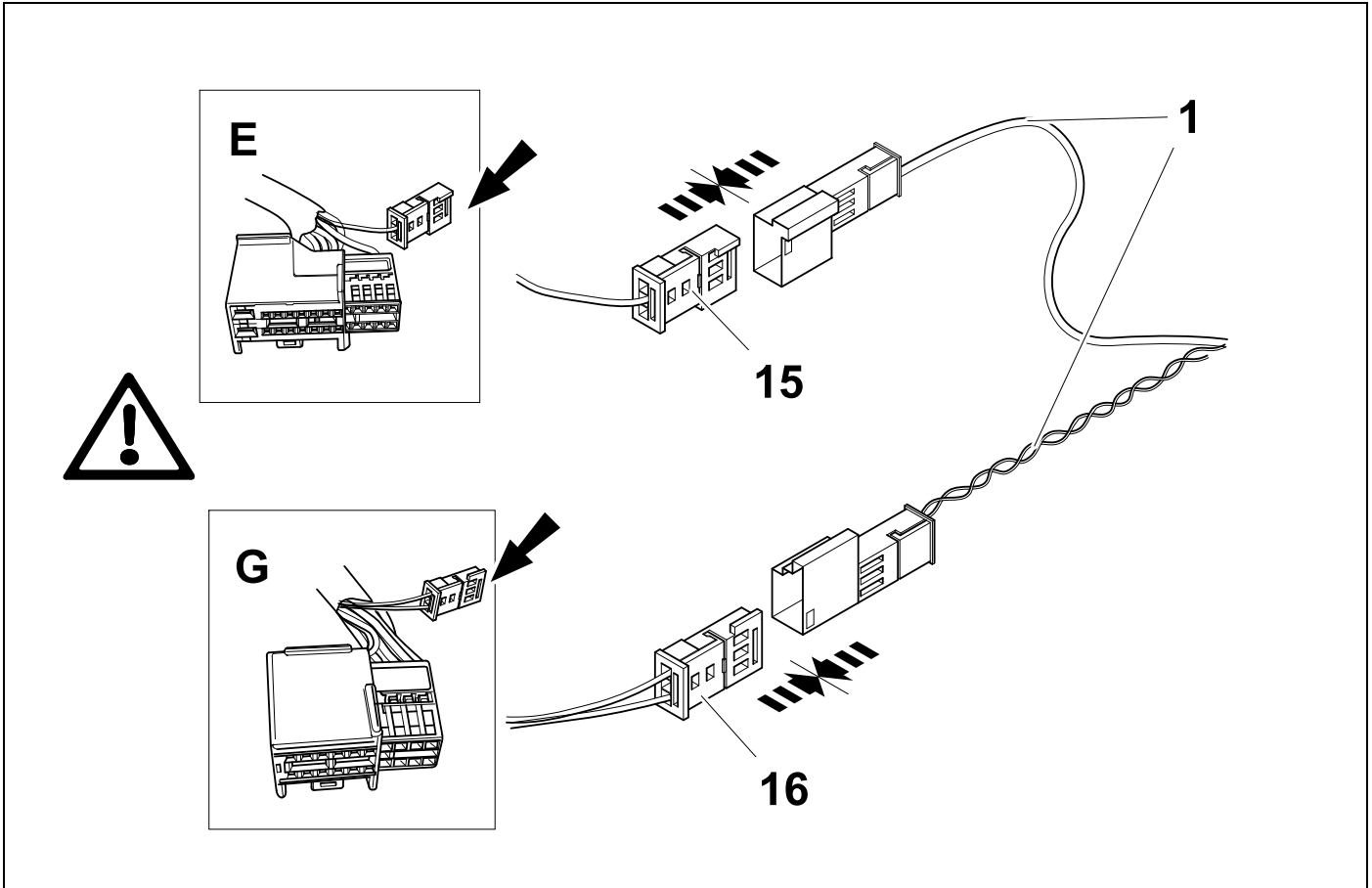

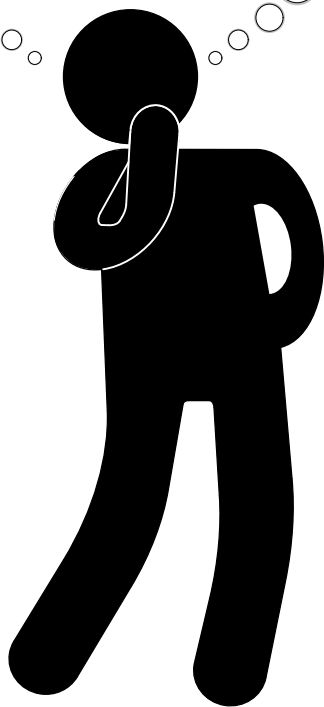
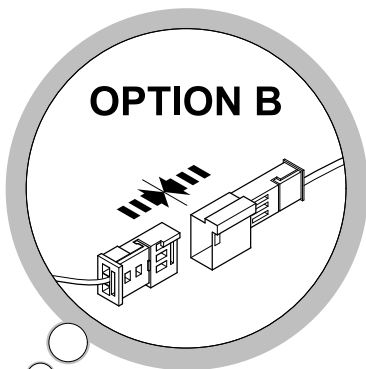
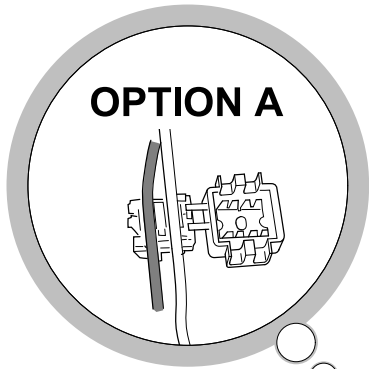

**OPTION A**

$$\begin{array}{r} \boxed{31} - \boxed{34} \\ + \\ \boxed{37} - \boxed{65} \end{array}$$

**OPTION B**

$$\begin{array}{r} \boxed{31} \\ + \\ \boxed{35} - \boxed{65} \end{array}$$

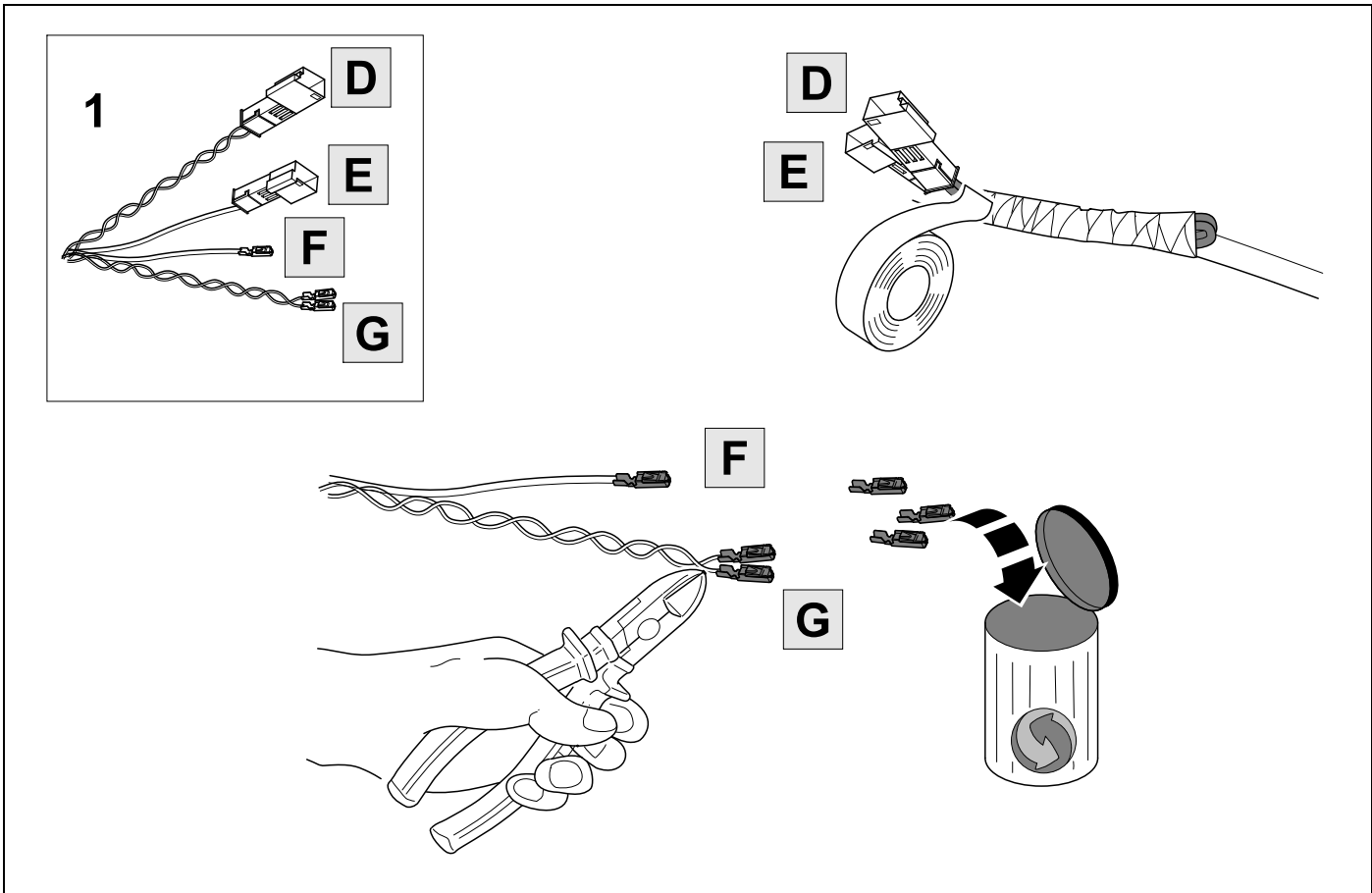
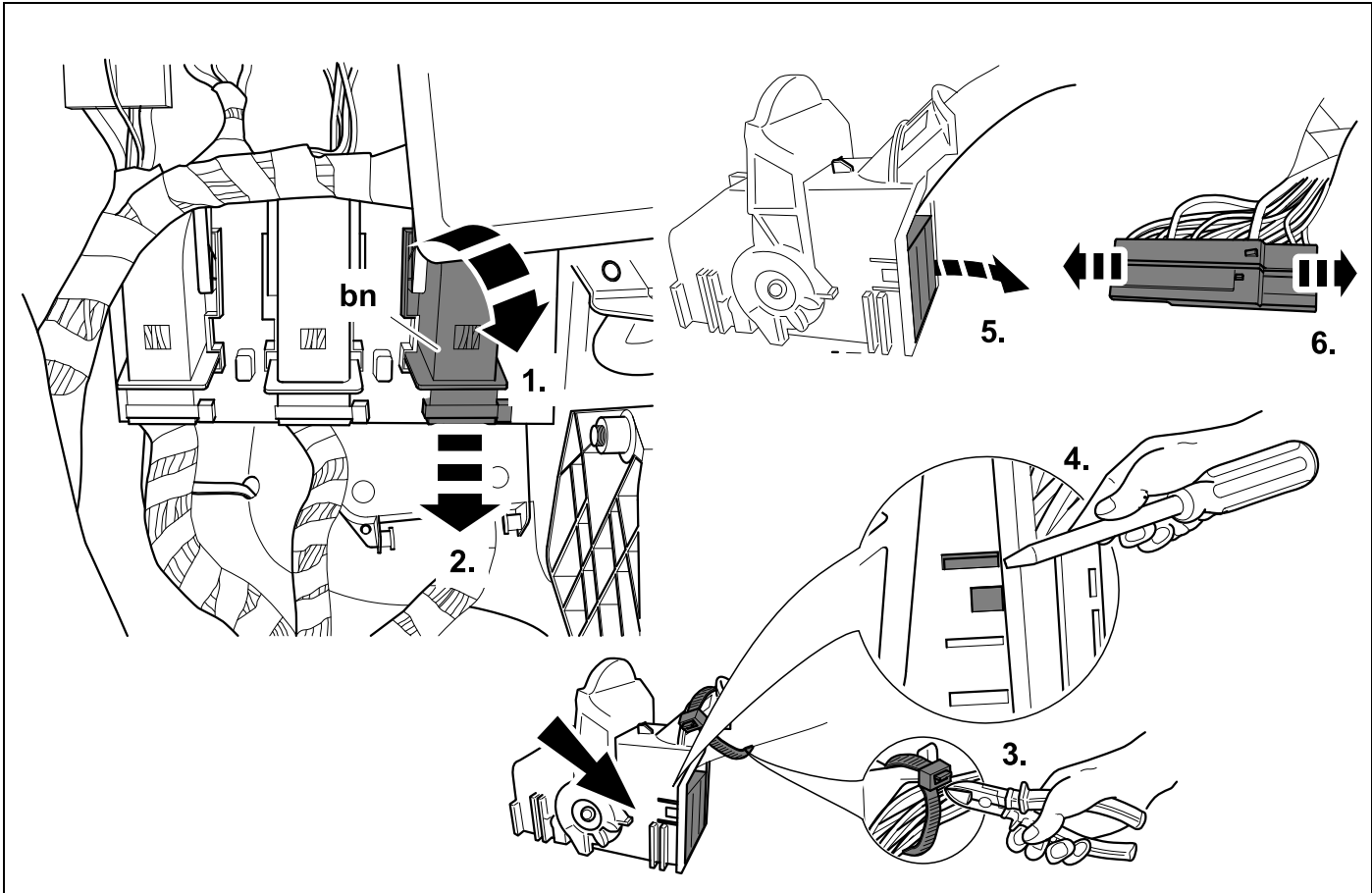



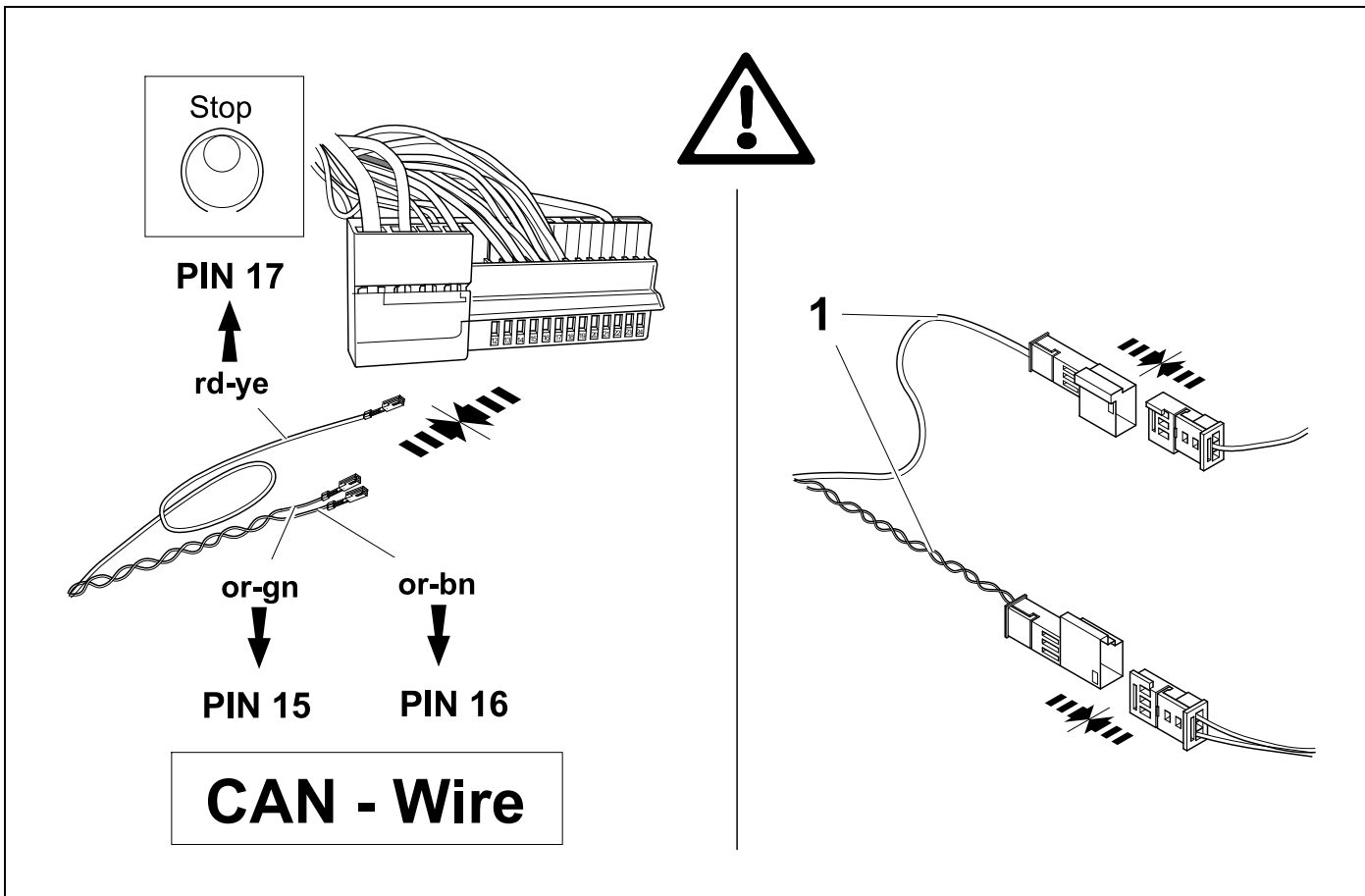
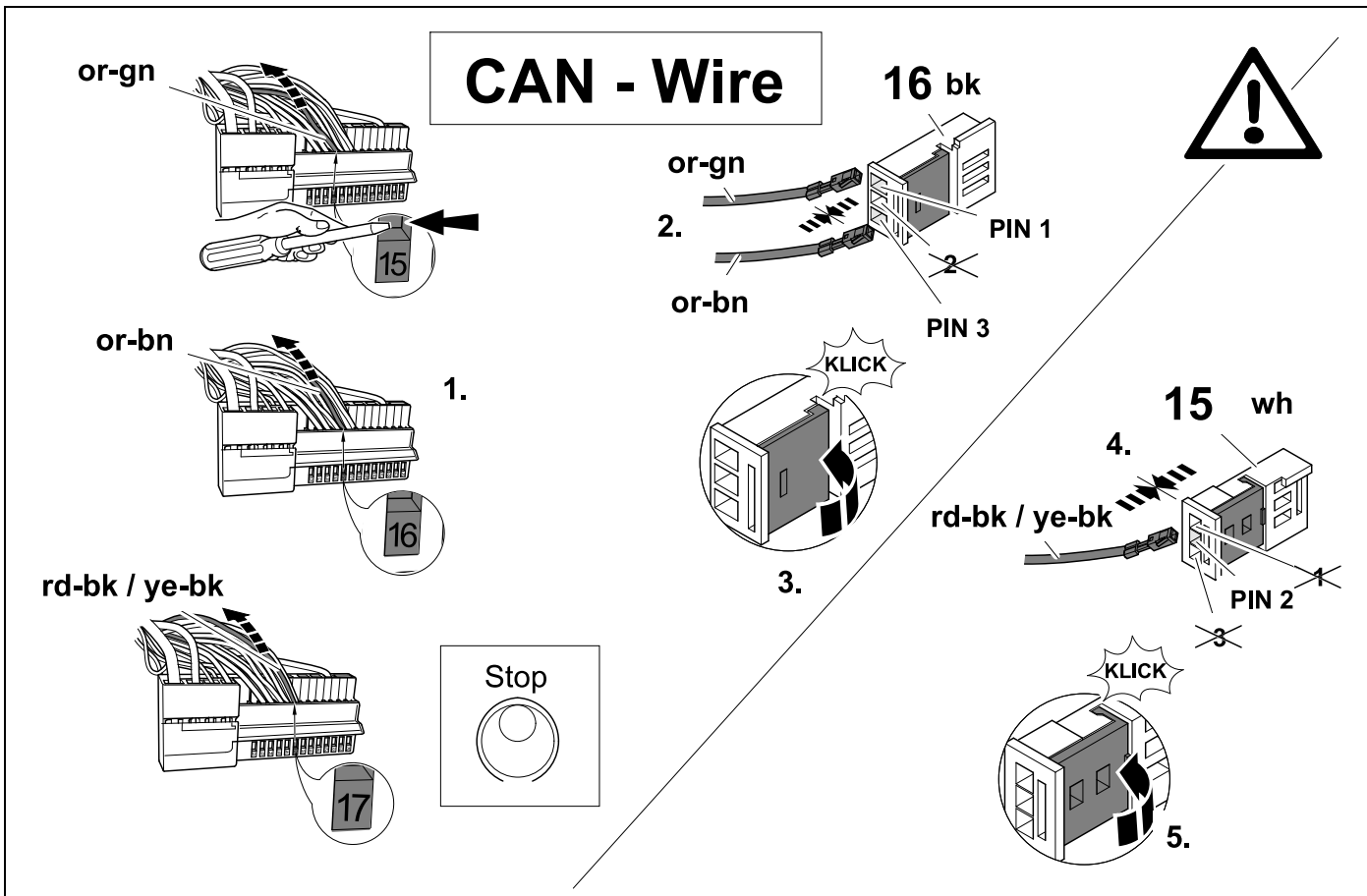

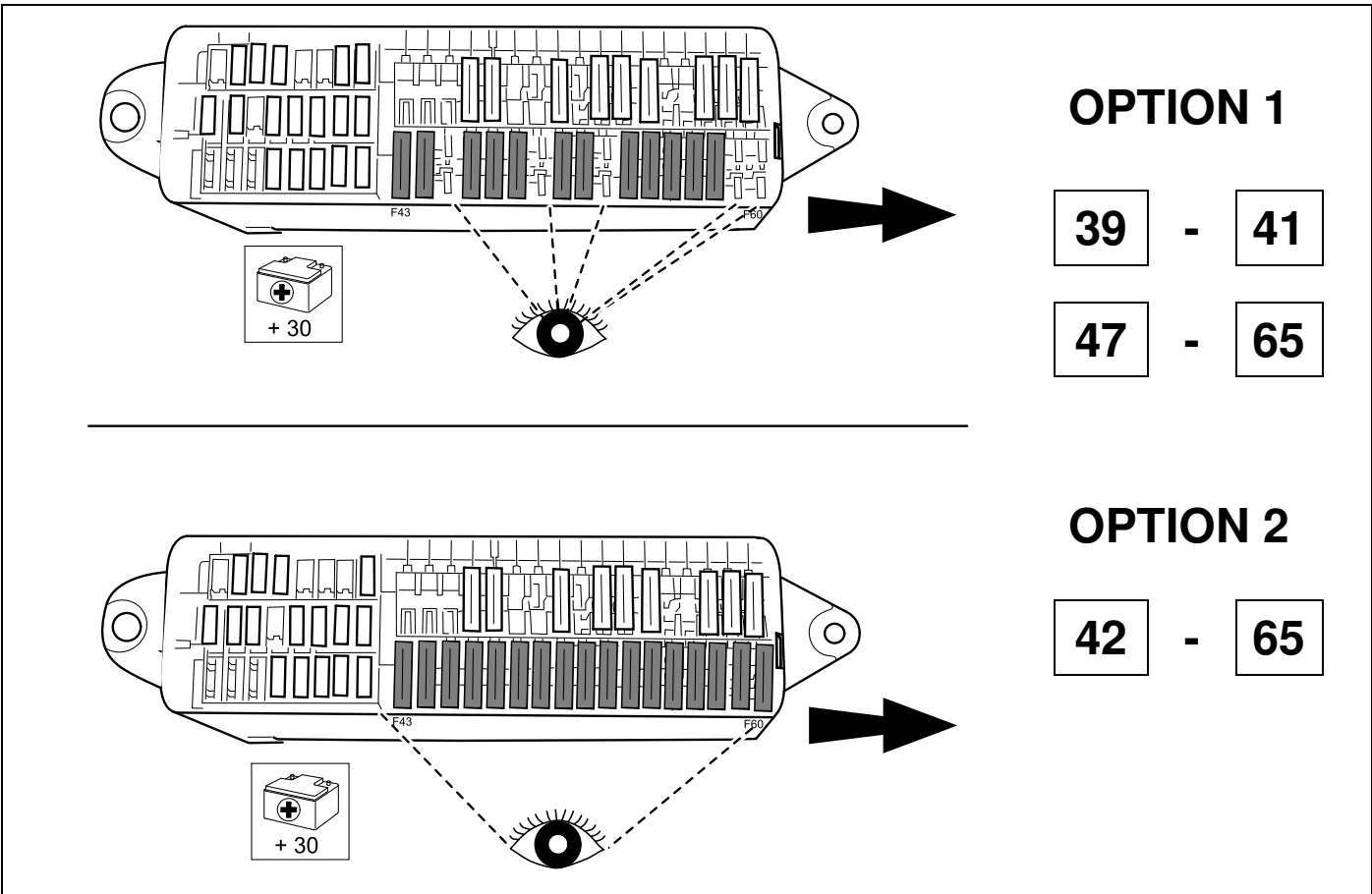
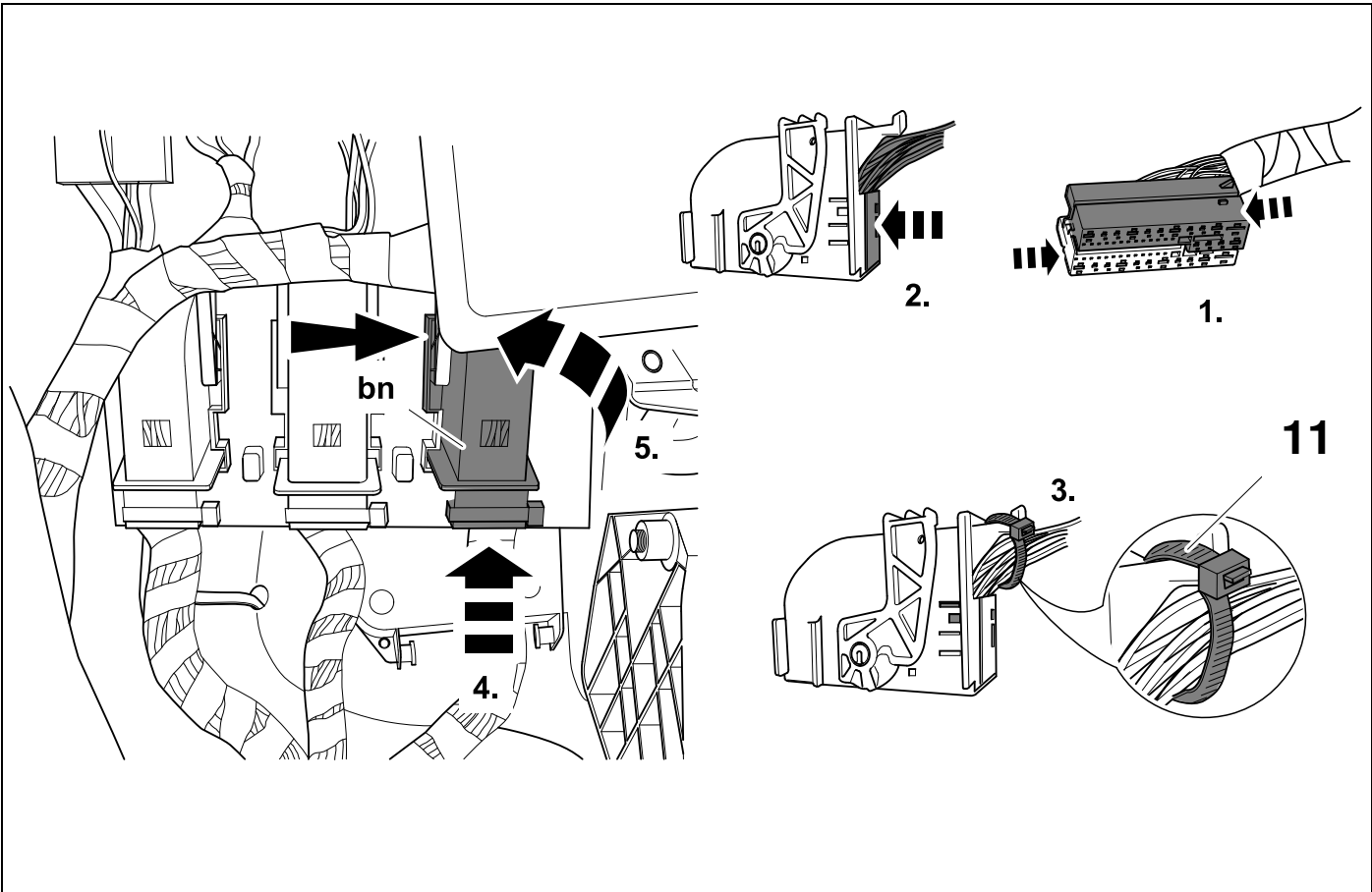

# 39 OPTION 1

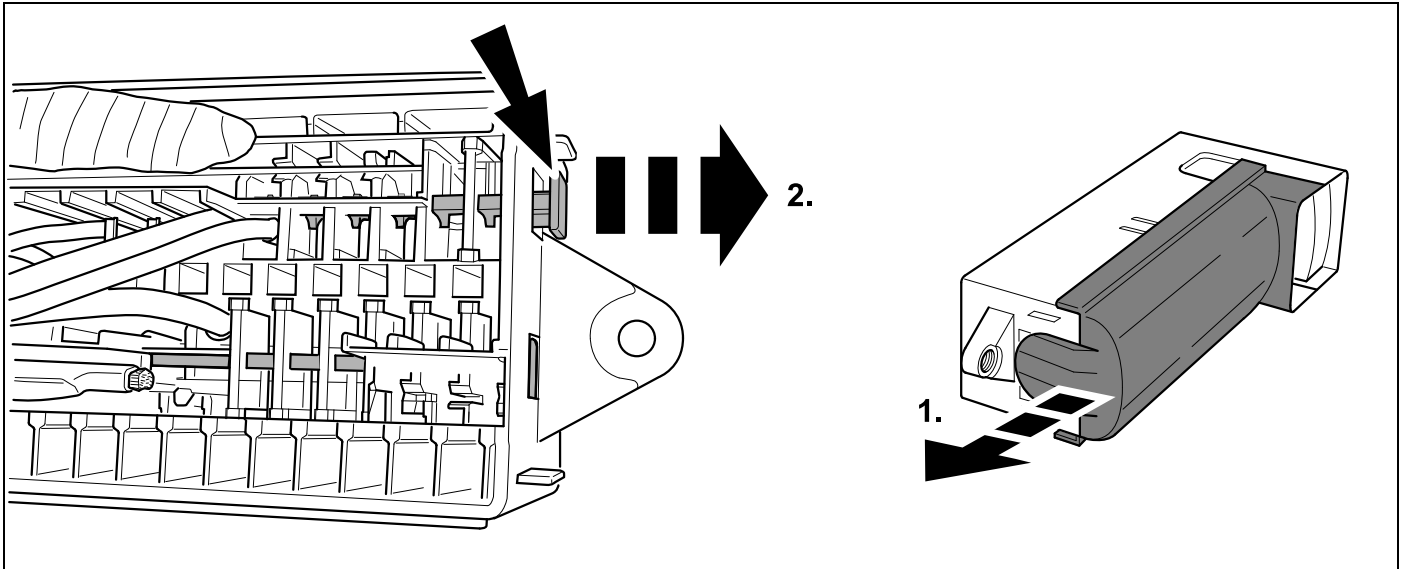

# 40 OPTION 1



6

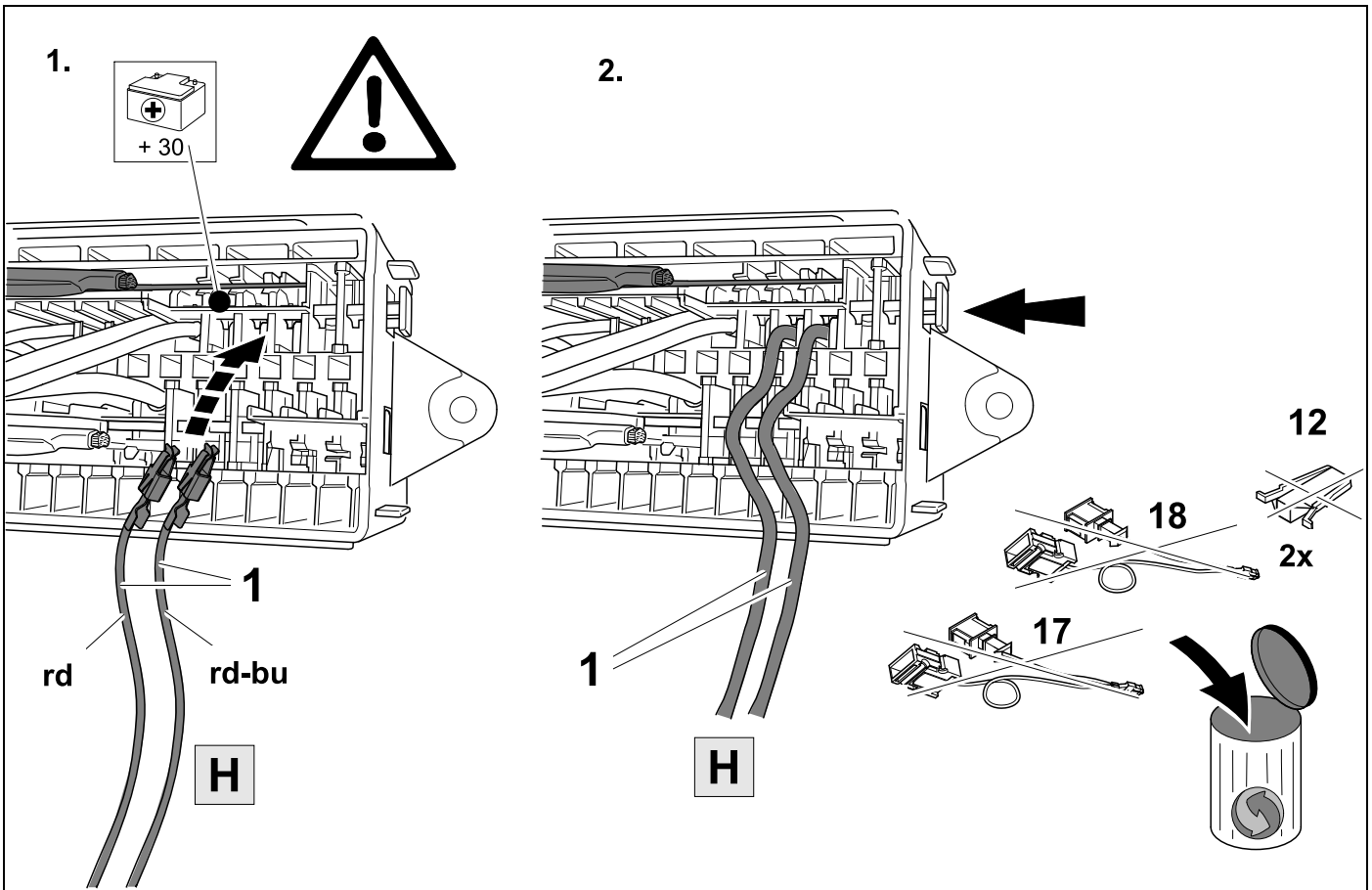



**41** **OPTION 1**



**6** + **54**

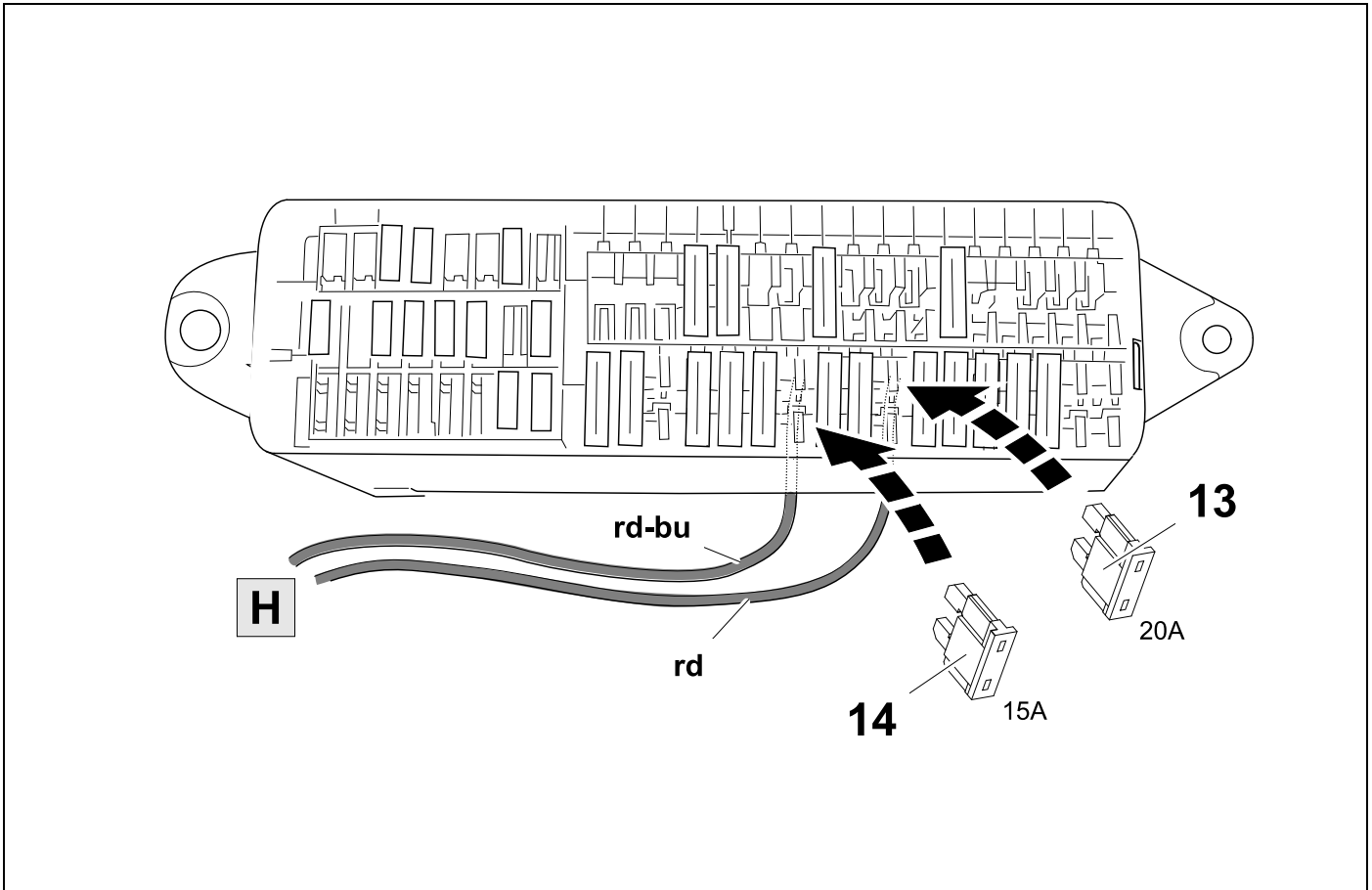

**42** **OPTION 2**



**45**

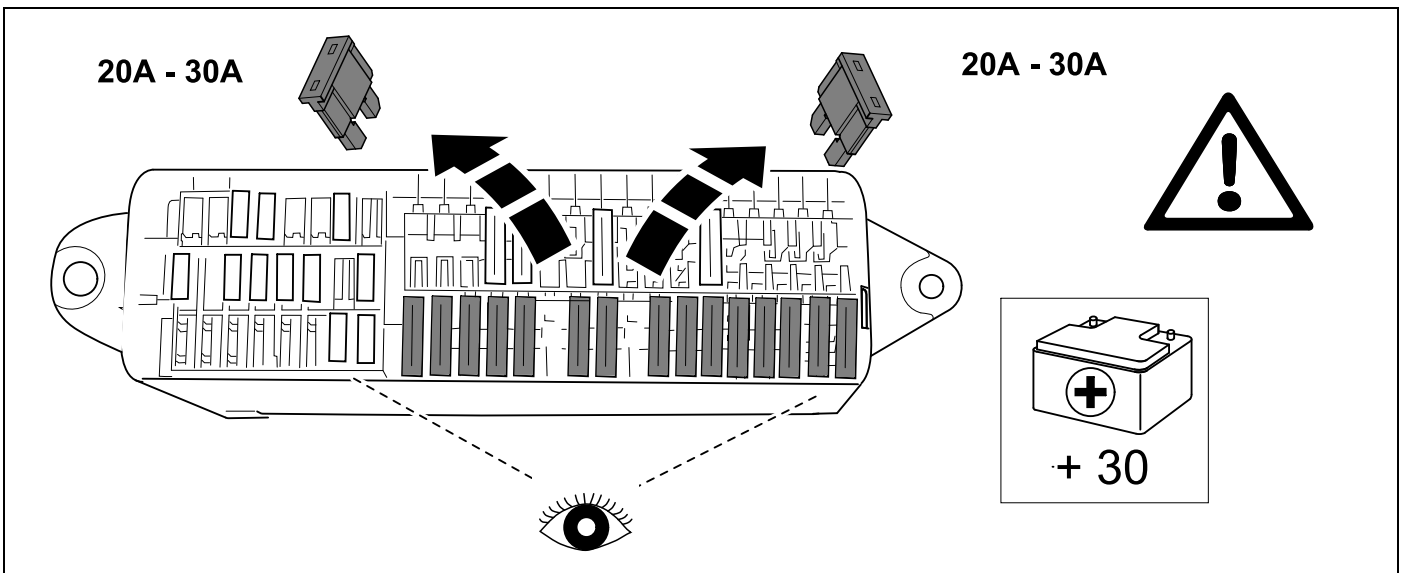

# 43 OPTION 2



6

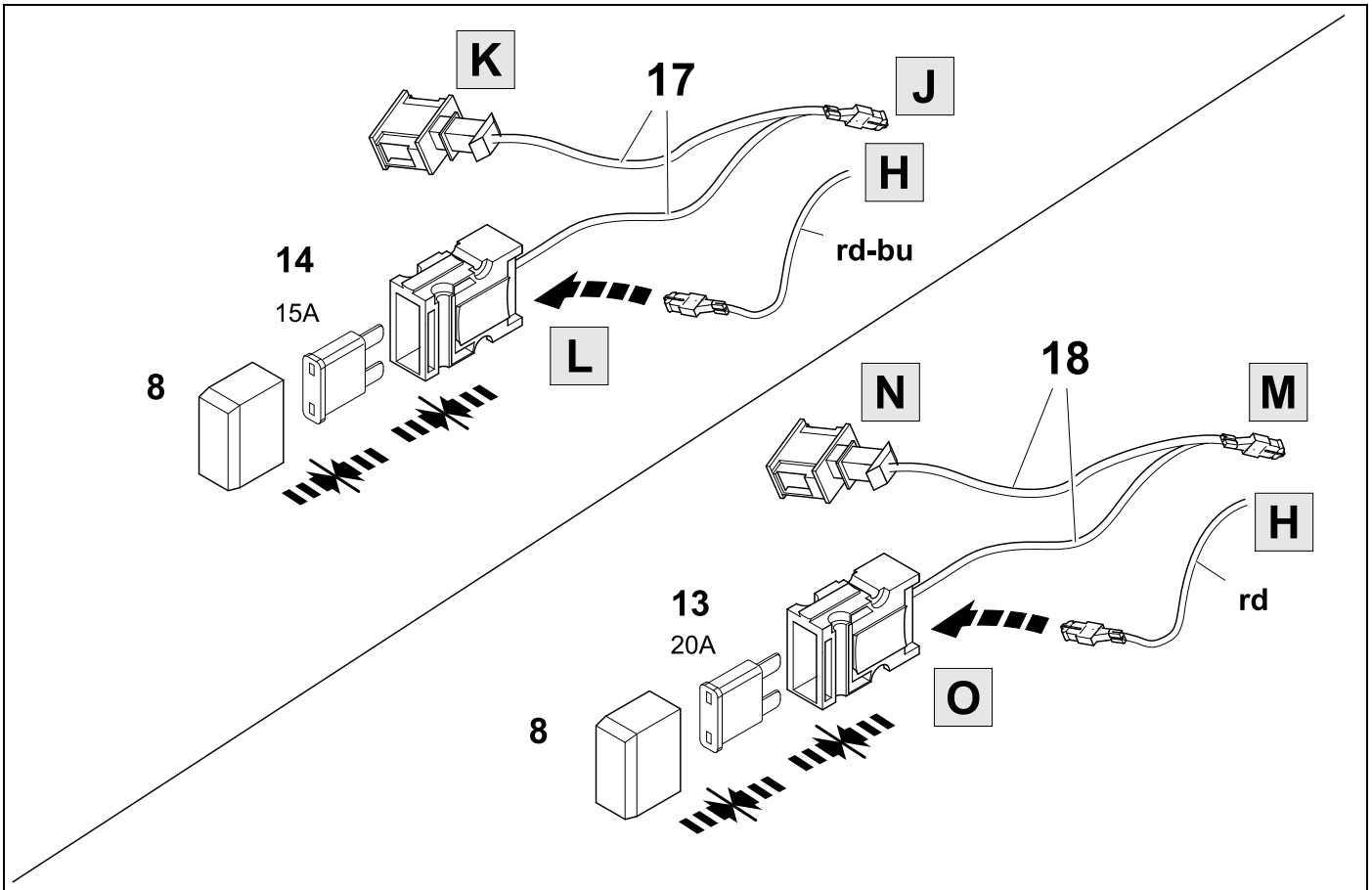

# 44 OPTION 2

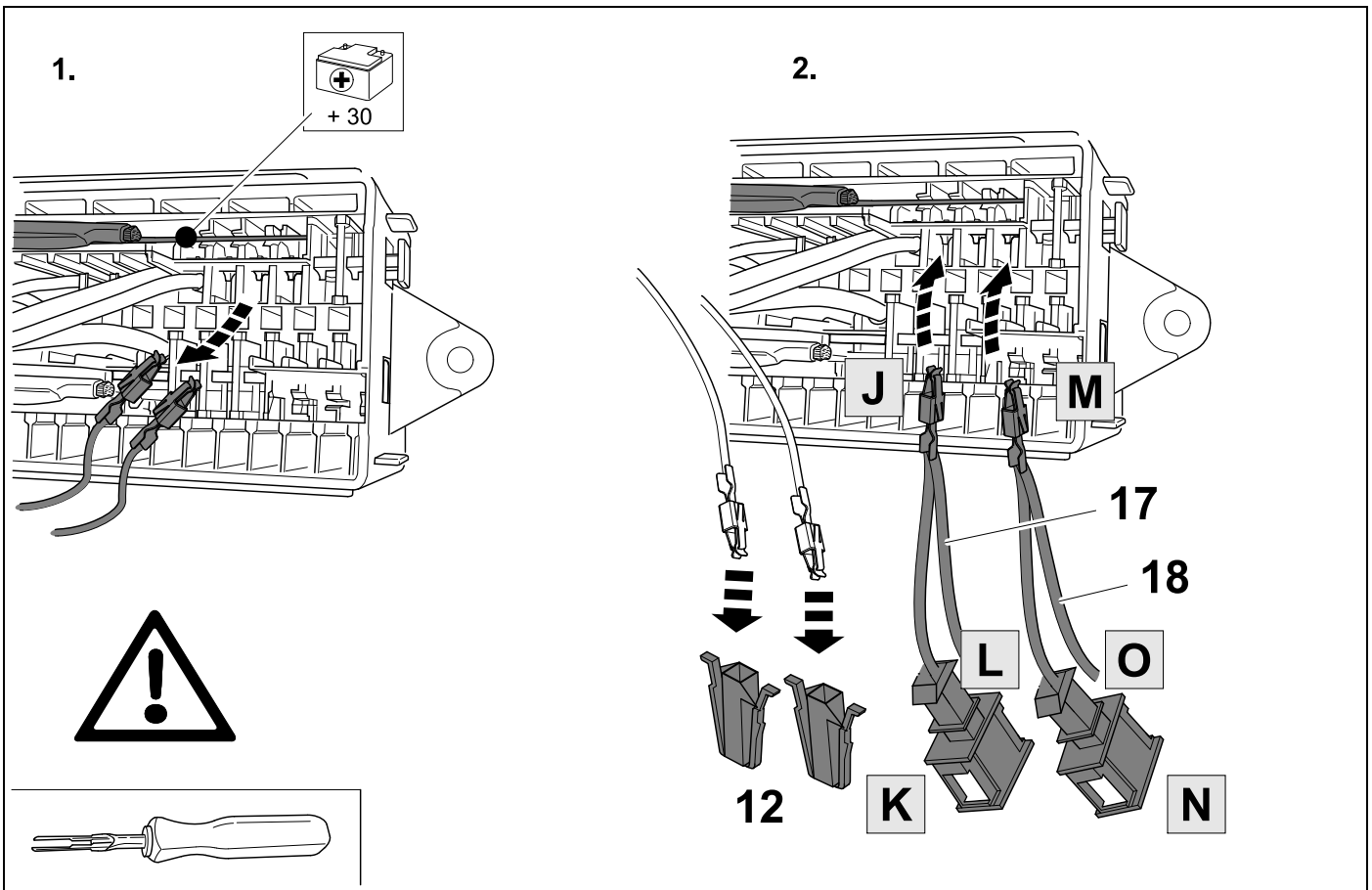

**45** OPTION 2



**42**

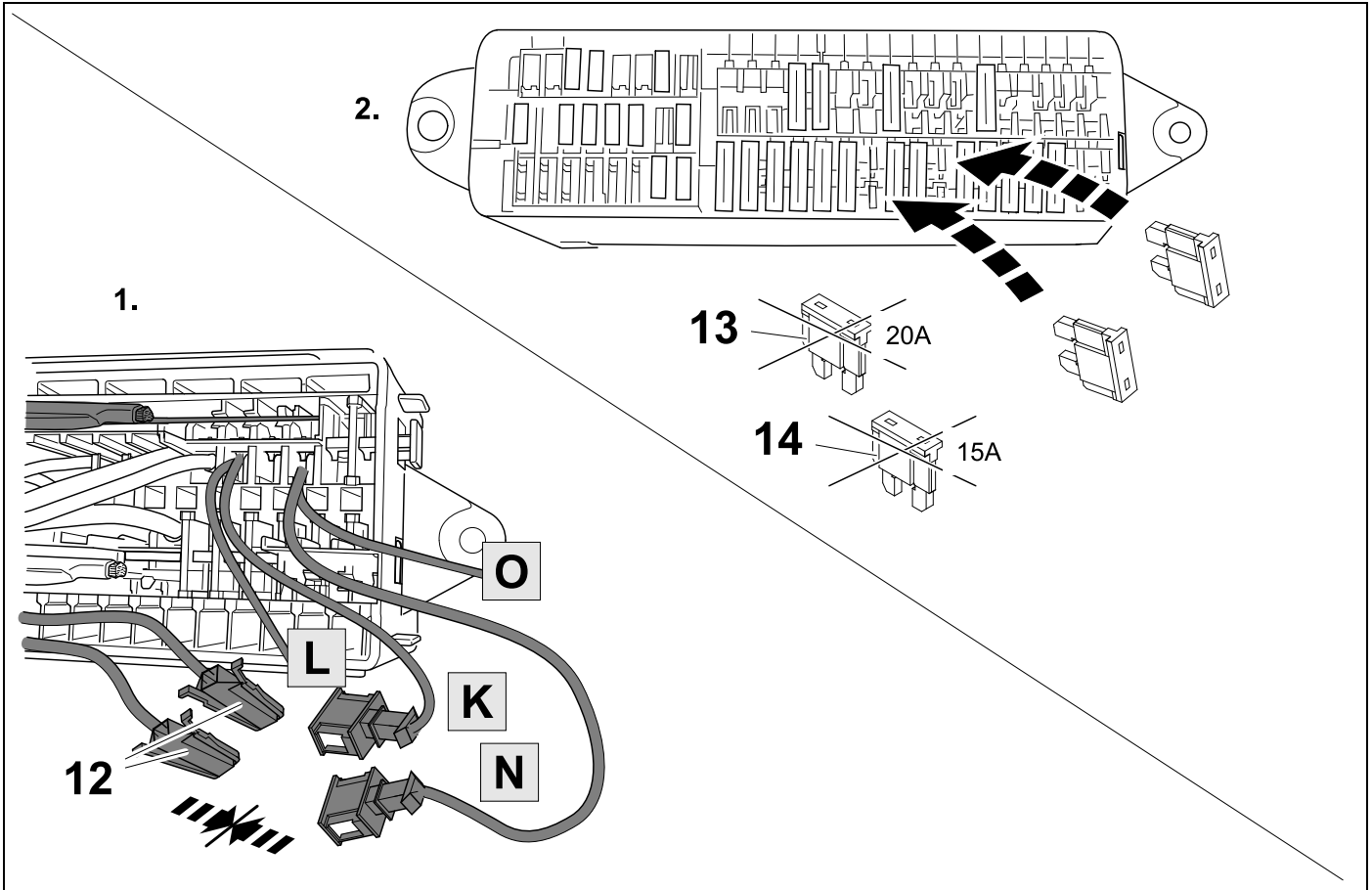

**46** OPTION 2



**54**

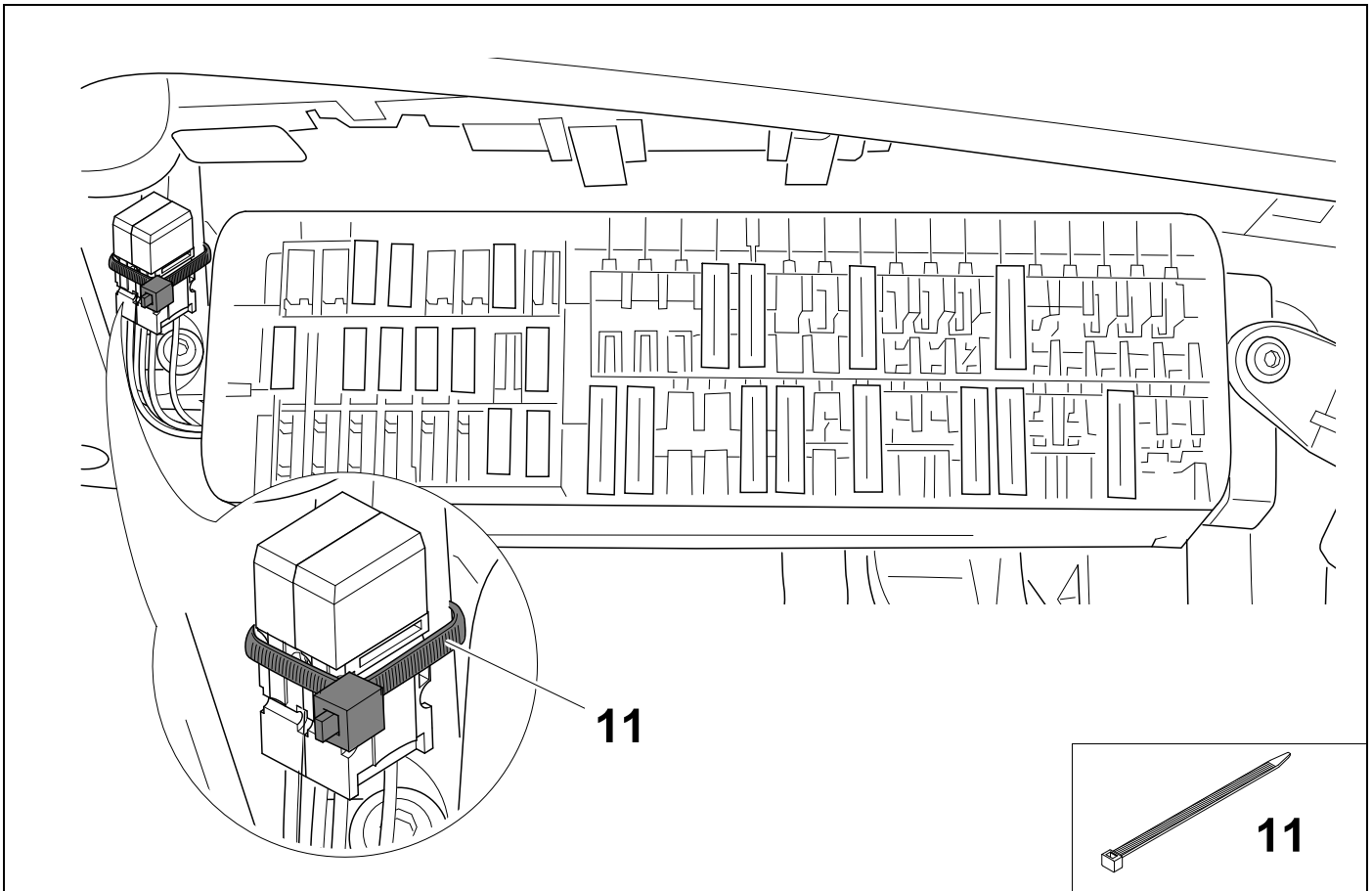

47

764159

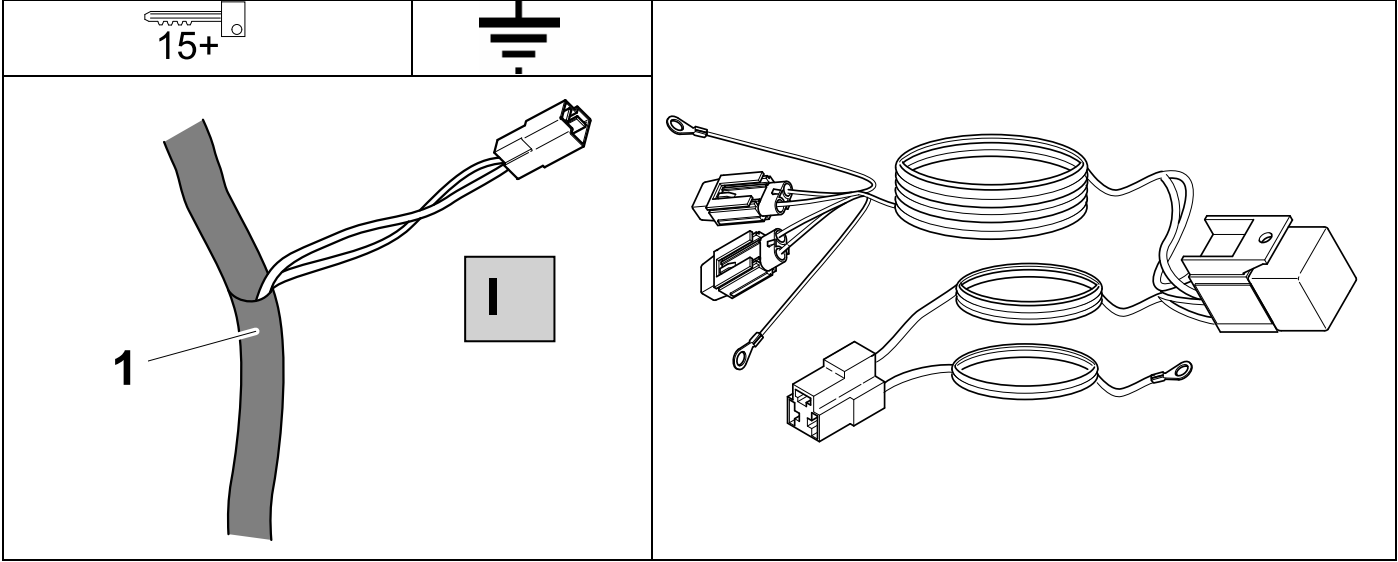

48

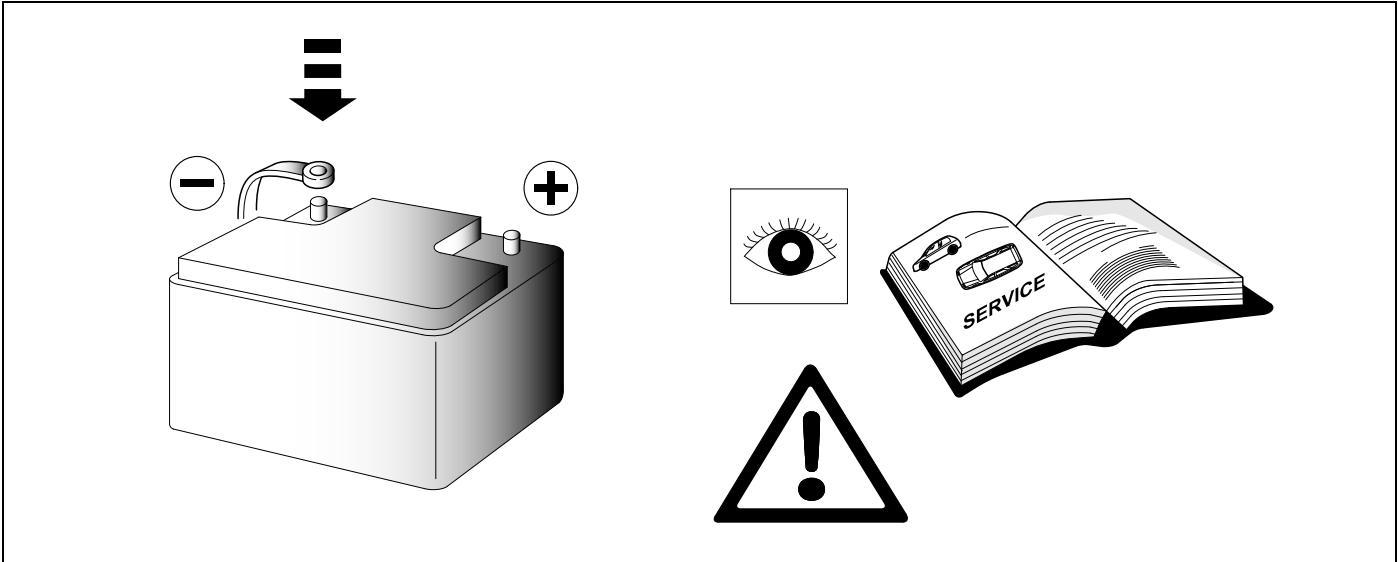

<p><b>D</b></p> <p>Folgende Beleuchtungsfunktionen des Anhängers werden nicht bei allen Zugfahrzeugen mit Tagesfahrlichtschaltung unterstützt:</p> <ul style="list-style-type: none"> <li>- <b>Schlussleuchten</b></li> <li>- <b>Begrenzungsleuchten</b></li> <li>- <b>Kennzeichenbeleuchtung</b></li> </ul> <p>Zur Aktivierung dieser Funktionen muss Stand oder Abblendlicht eingeschaltet werden!</p>	<p><b>I</b></p> <p>Le seguenti funzioni per l'illuminazione del rimorchio non sono supportate da tutte le motrici con circuito di luci diurne:</p> <ul style="list-style-type: none"> <li>- <b>luci posteriori</b></li> <li>- <b>luci d'ingombro</b></li> <li>- <b>illuminazione targa</b></li> </ul> <p>Per attivare queste funzioni devono essere accese le luci di posizione o gli anabbaglianti!</p>
<p><b>GB</b></p> <p>The following lamp functions for the trailer are not supported by all towing vehicles with DRL circuit:</p> <ul style="list-style-type: none"> <li>- <b>Rear lights</b></li> <li>- <b>Side lights</b></li> <li>- <b>Numberplate lights</b></li> </ul> <p>The parking lights or dimmed headlights must be switched on to activate this function!</p>	<p><b>NL</b></p> <p>De volgende verlichtingsfuncties van de aanhanger worden niet bij alle trekkende voertuigen met daglichtschakeling ondersteund:</p> <ul style="list-style-type: none"> <li>- <b>Achterlichten</b></li> <li>- <b>Spatbordlampen</b></li> <li>- <b>Kentekenverlichting</b></li> </ul> <p>Ter activering van deze functies moet parkeer- of dimlicht worden ingeschakeld!</p>
<p><b>F</b></p> <p>Les fonctions d'éclairage suivantes de la remorque ne sont pas activables sur tous les véhicules de traction équipés de feux de circulation de jour:</p> <ul style="list-style-type: none"> <li>- <b>Feux arrières</b></li> <li>- <b>Feux d'encombrement</b></li> <li>- <b>Éclairage de la plaque minéralogique</b></li> </ul> <p>Pour activer ces fonctions, les feux de position ou de croisement doivent être allumés!</p>	<p><b>E</b></p> <p>No todos los vehículos tractores con conmutación de luz de marcha diurna ofrecen un soporte para las siguientes funciones de iluminación del remolque:</p> <ul style="list-style-type: none"> <li>- <b>Luces traseras</b></li> <li>- <b>Luces de gálibo</b></li> <li>- <b>Iluminación de la matrícula</b></li> </ul> <p>¡Para activar estas funciones deberán encenderse las luces de posición o las luces de cruce!</p>

## 50 CHECK

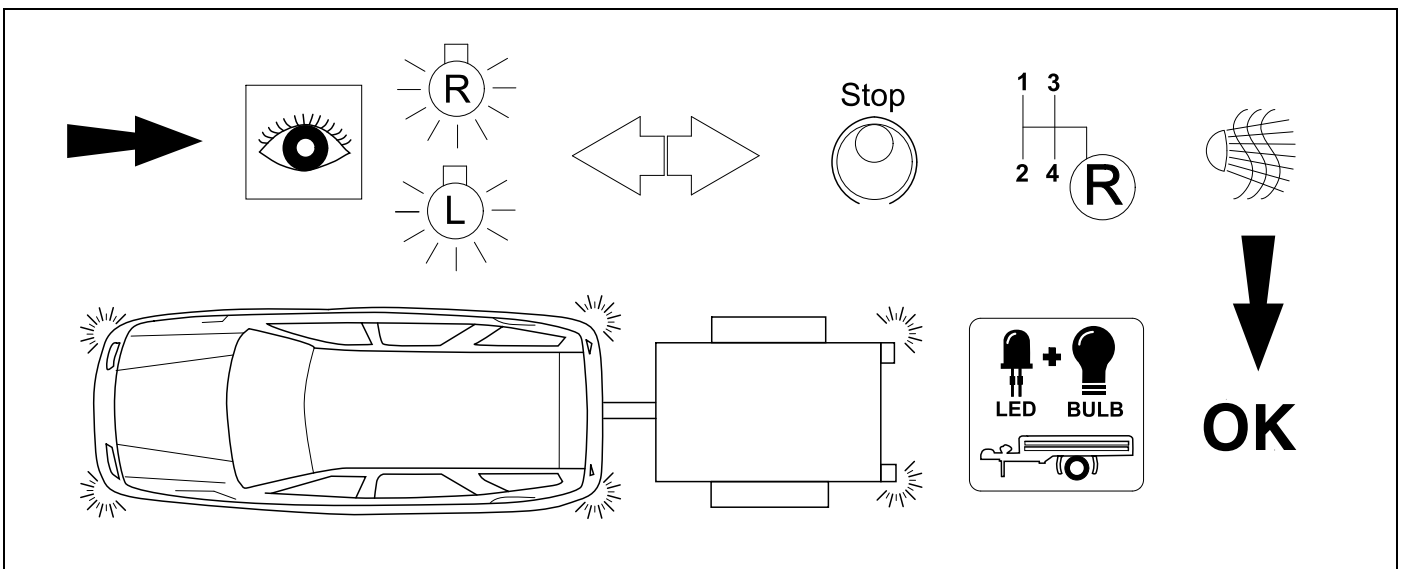

**51** OPTIONAL

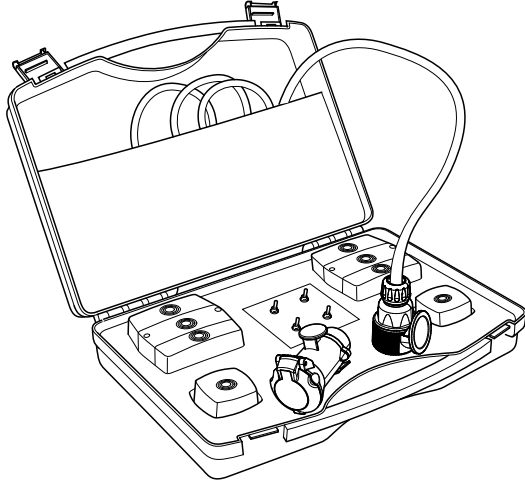

**Trailer Simulator  
for 7p and 13p  
sockets**

**765069**

**52** CHECK

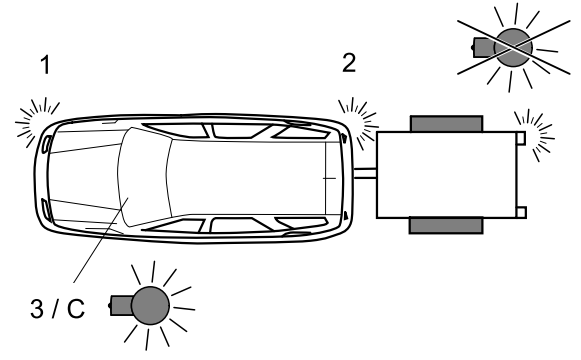
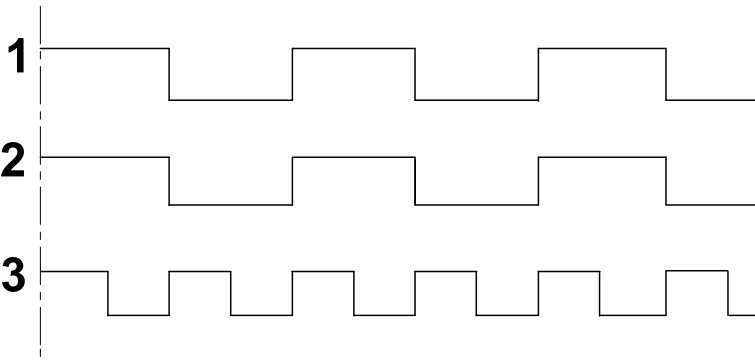

**53** CHECK OPTION ORIGINAL PDC

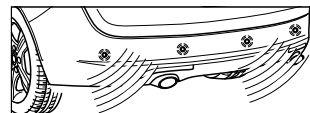
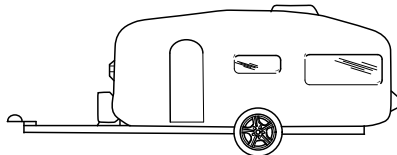
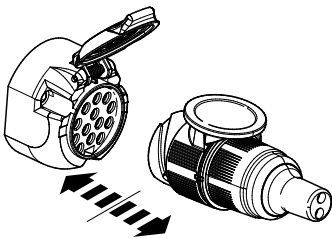
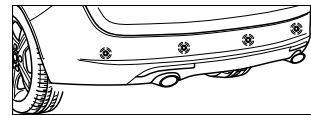
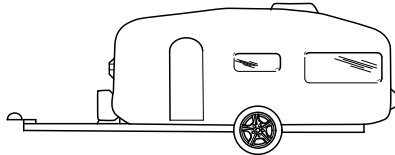
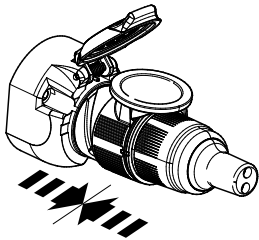

**54 Information Service**



**41 + 46**

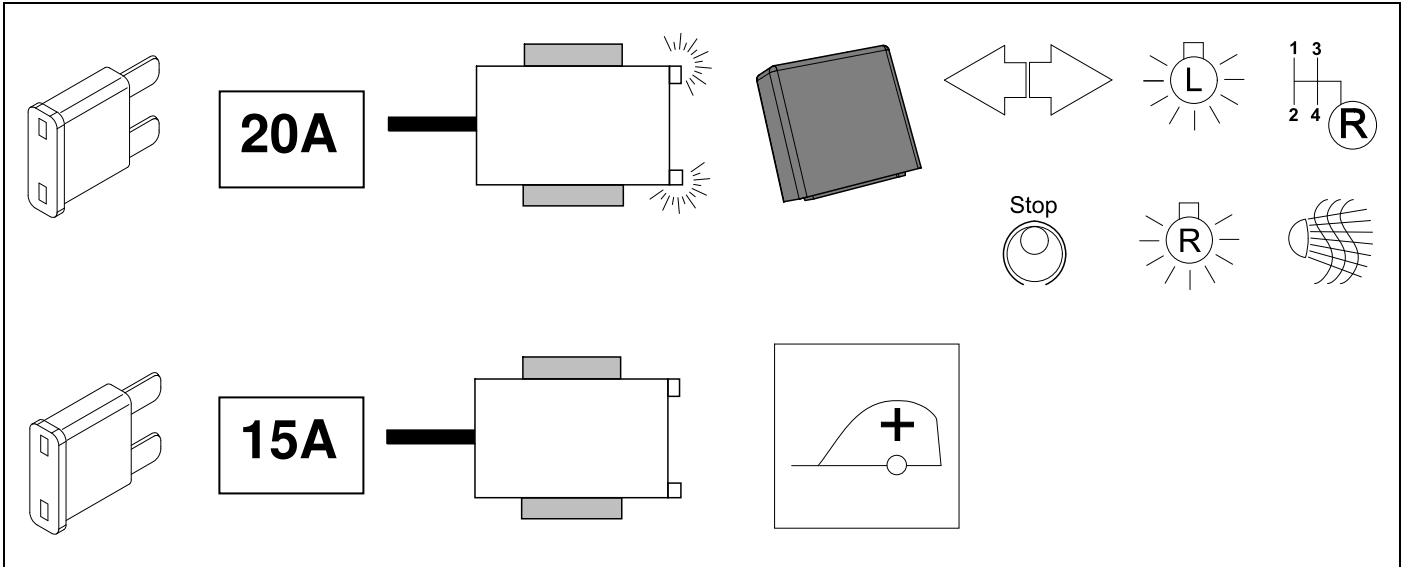

**55 OPTIONAL**



**BRiNK**

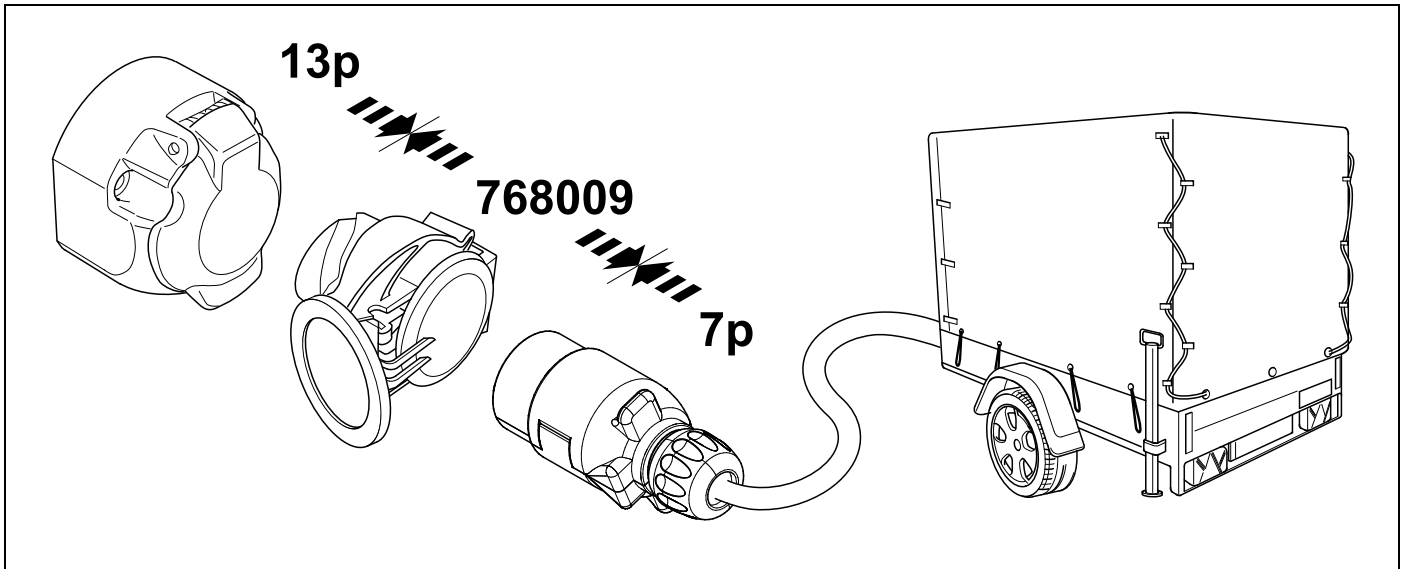

**56 PLEASE NOTICE**

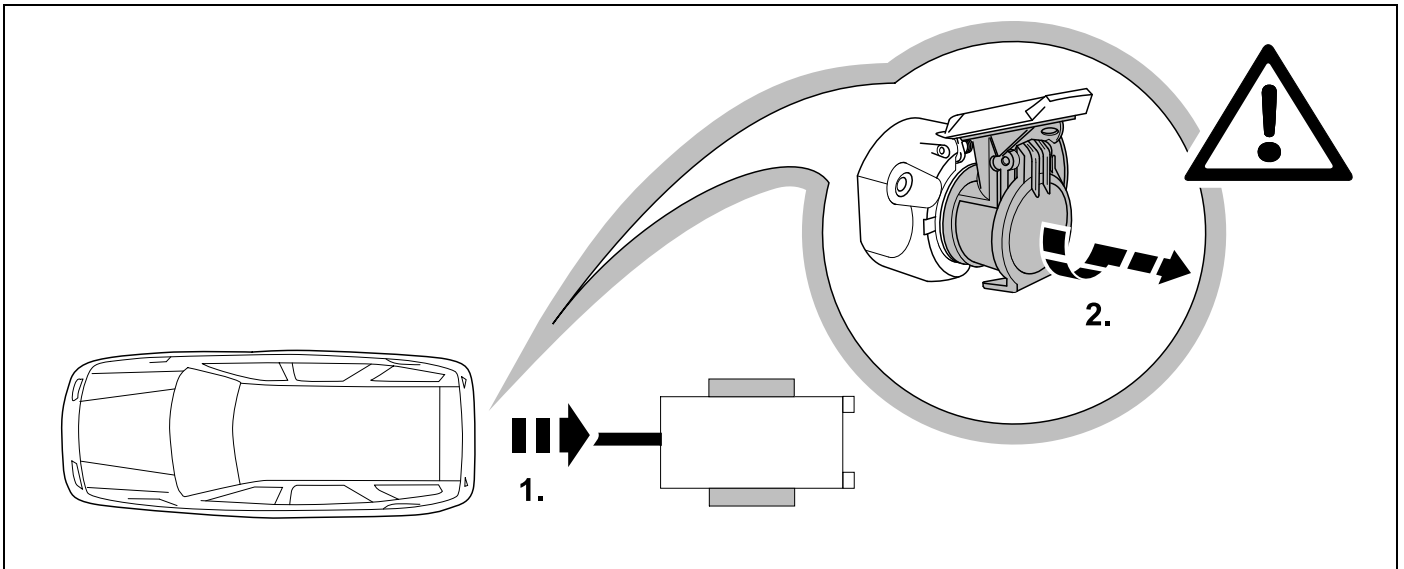

## 57 Information Service

### Grundausrüstung

- Ohne Zentralverriegelung
- Mit Bordnetzsteuergerät VW 1K0 937 049



### Basic configuration

- without central locking system
- with network control unit VW 1K0 937 049

### **Nebelschlusslicht-Abschaltung nachrüsten!**

Bitte kontaktieren sie Thule Towing Systems für weitere Informationen über den Erweiterungssatz.

### **Retrofit rear fog light cut-off!**

Please contact Thule Towing Systems for more info regarding the extension kit.

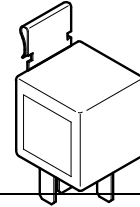
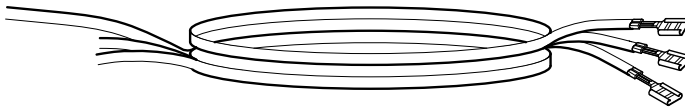

## 58 Jifeline Coding

### OPTION 1



### **Need help programming this wiringkit?**

If possible, we provide tips in our manuals on how the vehicle can be coded. It is always possible that more or different coding steps are required for your specific vehicle. That is why we recommend the use of Jifeline.

Jifeline codes your vehicle online with the most up to date knowledge.



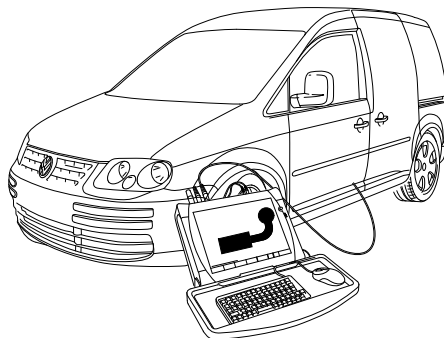

D

### Codieren des Gatewaysteuergerätes

Das fahrzeugseitige Gateway muss wie nachfolgend beschrieben, unter dem Punkt Eigendiagnose, mit einem VAS-Tester zur Funktionserweiterung Anhängervorrichtung codiert werden:

- Fahrzeug-Eigendiagnose
- Gateway-Verbauliste
- 19 – Diagnoseinterface für Datenbus
- 007-Codierung (Dienst \$1A) \ Lange Codierung lesen / schreiben
- 69 – Anhängerfunktion (auf codiert schalten!)

### Codieren des Einparkhilfesteuergerätes

Nach erfolgter Freischaltung wird im Anhängerbetrieb auch die rückwärtige Einparkhilfe automatisch deaktiviert!

### Anpassen des Bordnetzsteuergerätes

Wird die fahrzeugseitige Nebelschlussleuchte bei Anhängerbetrieb nicht abgeschaltet, muss gegebenenfalls das Bordnetzsteuergerät wie folgt codiert werden:

- Adresswort 09 – Elektronische Zentralelektrik
- Identifikation: Weiter
- Diagnosefunktion auswählen: 007 – Codierung (Dienst 1A)
- Fahrzeugsystem auswählen: Bordnetz-SG Codierung lang
- Wert ändern: Byte 8 Bit-Muster x1xxxxxx (x: die vorhandenen Werte in das Eingabefeld eingeben) Dazu auf Eingabemodus [BIN] schalten.

GB

### Encoding the gateway controller

The vehicle gateway must be encoded, as described below, under the point self-diagnostics, by means of a VAS tester for functional expansion of the towing hitch function:

- Vehicle self-diagnosis
- Gateway assembly list
- 19 – diagnosis interface for data bus
- 007-Coding (service \$1A) \ Read / write
- long coding
- 69 – trailer function ( switch to coded!)

### Vehicles with park assist system

After the effected connection, the rear park assist system will also automatically be deactivated in trailer operation!

### Adapting the on-board power control unit

If the rear fog light on the towing vehicle is not disabled when towing a trailer, the on-board power control unit has to be encoded as follows where necessary:

- Address word 09 – Central electrical system
  - Identification: Continue
  - Selecting diagnosis function: 007 – Coding (Service 1A)
  - Select vehicle system: On-board power control unit – control unit encoding long
  - Change the value: Byte 8 Bit pattern x1xxxxxx (x: enter the existing values in the input field)
- For this purpose switch to input mode [BIN].

F

### Codage du calculateur Gateway

Coder comme suit le Gateway du véhicule selon la description suivante, point diagnostic final, avec un contrôleur VAS pour l'extension du dispositif d'attelage :

- autodiagnostic du véhicule
- liste d'assemblage gateway
- 19 – interface de diagnostic pour bus de données
- 007-codage (service \$1A) \ lire / écrire uncode long
- 69 – mode remorque ( commuter à encodé!)

### Véhicules avec système d'aide au parking

Après l'activation, l'aide au parking arrière est également désactivé automatiquement dans le mode remorque!

### Adaptation du calculateur du réseau de bord

Si les feux antibrouillard du véhicule ne sont pas éteints lorsque la remorque est attelée, coder éventuellement le calculateur du réseau de bord comme suit :

- Mot d'adresse 09 - Système électrique central électronique
- Identification : Continuer
- Sélectionner la fonction diagnostic : 07 - Codage (service 1A)
- Sélectionner le système du véhicule : Réseau de bord Codage calculateur long
- Modifier la valeur du code : Octet schéma 8 bits x1xxxxxx (x: entrer les valeurs dans le champ de saisie) A cette fin, basculer sur le mode de saisie [BIN].

I	E	NL
<p><b>Codifica della centralina gateway</b></p> <p>Il gateway della vettura, per l'espansione delle funzioni al gancio traino, deve essere codificato con un tester VAS nell'autodiagnosi, nel modo descritto qui di seguito:</p> <ul style="list-style-type: none"> <li>- Autodiagnosi del veicolo</li> <li>- Lista del Gateway</li> <li>- 19 – Interfaccia di diagnosi per il data bus</li> <li>- 007-codifica (servizio \$1A) \ Lettura e scrittura di codici lunghi</li> <li>- 69 – Funzione rimorchio (commutare su codificato!)</li> </ul> <p><b>Veicoli con sensori di parcheggio</b></p> <p>Dopo aver completato l'attivazione, i sensori di parcheggio posteriori vengono disattivati automaticamente quando è attaccato un rimorchio!</p> <p><b>Adattamento della centralina della rete di bordo</b></p> <p>Se la luce retronebbia, con il rimorchio agganciato, non si spegne, occorre codificare la centralina della rete di bordo nel modo seguente:</p> <ul style="list-style-type: none"> <li>- codice indirizzo 09 – impianto elettrico centrale elettronico</li> <li>- identificazione: avanti</li> <li>- selezionare la funzione diagnostica: 07 – codifica (servizio 1A)</li> <li>- selezionare il sistema vettura: rete di bordo – codifica centralina lunga</li> <li>- modificare il valore: byte 8 modello bit x1xxxxx (x: inserire i valori presenti nel campo d'immissione) A tale scopo passare alla modalità d'immissione [BIN].</li> </ul>	<p><b>Codificación de la unidad de control del Gateway</b></p> <p>El Gateway del vehículo debe codificarse con un analizador VAS para ampliar las funciones del dispositivo de remolque en el autodiagnóstico, como se describe seguidamente:</p> <ul style="list-style-type: none"> <li>- Autodiagnóstico del vehículo</li> <li>- Lista Gateway</li> <li>- 19 - Interfaz de diagnóstico para bus de datos</li> <li>- 007-Codificación (servicio \$1A) \ Leer / escribir la codificación larga</li> <li>- 69 - Función del remolque (codificación)</li> </ul> <p><b>Vehículo llevar a cabo la codificación de la siguiente manera:</b></p> <p>¡Tras haber realizado la activación, también se desactivará automáticamente la ayuda trasera al aparccamiento en la conducción con remolque!</p> <p><b>Adaptar la unidad de control de la red de a bordo</b></p> <p>Si la luz antiniebla trasera del vehículo no se desconecta durante la conducción con remolque, se deberá codificar eventualmente la unidad de control de la red de a bordo de la siguiente manera:</p> <ul style="list-style-type: none"> <li>- Código 09 – Sistema eléctrico central electrónica</li> <li>- Identificación: Otros</li> <li>- Seleccionar función de diagnóstico: Codificación 007 (servicio 1A)</li> <li>- Seleccionar sistema del vehículo: Codificación larga unidad de control red de a bordo</li> <li>- Cambiar valor: Byte 8 configuración de bits x1xxxxx (x: introducir los valores existentes en el campo de entrada) Para ello, cambiar al modo de entrada [BIN].</li> </ul>	<p><b>Coderen van het gateway besturingsapparaat</b></p> <p>De gateway aan voertuigzijde moet zoals hierna beschreven onder punt Eigendiagnose, met een VAS-tester voor de functie-uitbreiding aanhangwageninrichting</p> <ul style="list-style-type: none"> <li>- Eigen diagnose voertuig</li> <li>- Gateway-inbouwlijst</li> <li>- 19 – diagnose-interface für gegenwärtigen bus</li> <li>- 007-Codierung (dienst \$1A) \ Lange codering lezen/schrijven</li> <li>- 69 – aanhangwagenfunctie (op "Gecodeerd" schakelen!)</li> </ul> <p><b>Voertuigen met parkeerhulp</b></p> <p>Nadat de activering doorgevoerd werd, wordt in de modus „Aanhangwagen“ ook het hulpmiddel bij het achterwaartse, invogende parkeren automatisch geactiveerd!</p> <p><b>Aanpassen van het boordnetbesturingstoestel</b></p> <p>Wanneer het mistachterlicht aan voertuigzijde bij werking met aanhangwagen niet wordt uitgeschakeld, moet eventueel het boordnetbesturingstoestel als volgt worden gecodeerd:</p> <ul style="list-style-type: none"> <li>- Adreswoord 09 – Elektronische centrale elektrische systeem</li> <li>- Identificatie: Verder</li> <li>- Diagnosefunctie selecteren: 007 – Codering (Dienst 1A)</li> <li>- Voertuigstelsel selecteren: Boordnet – SG codering lang</li> <li>- Waarde veranderen: Byte 8 Bit-patroon x1xxxxx (x: de aanwezige waarde in het invoerveld invoeren) Hiervoor op invoermodus [BIN] schakelen.</li> </ul>

D

**Codierung bitte wie folgt durchführen:**

- Fahrzeug-Eigendiagnose
- Gateway-Verbauliste
- 19-Diagnoseinterface für Datenbus
- 007-Codierung (Dienst \$1A) \ Lange Codierung lesen / schreiben
- 69-Anhängerfunktion (auf codiert schalten!)

**Fahrzeuge mit Einparkhilfe****Die automatische Deaktivierung der rückwärtigen Einparkhilfe im Anhängerbetrieb wird durch nachfolgende Codierung des Einparkhilfe-Steuergeräts erreicht:**

- Fahrzeug-Eigendiagnose
- Gateway-Verbauliste
- 10 - Einparkhilfe II / Parklenkassistent
- 008 Codierung (Dienst \$22)
- Byte 0 Bit-Muster xxxxxx1 (x = die vorhandenen Werte im Eingabefeld übernehmen, dazu Eingabemodus (BIN) einschalten!)
- mit OK bestätigen!

**HINWEIS:**

**Sollte sich die fahrzeugseitige Nebelschlußleuchte nicht automatisch im Anhängerbetrieb abschalten, muß ergänzend zur oben genannten Konfiguration die Zentralelektrik wie folgt codiert werden:**

**Fahrzeug Eigendiagnose**

- 09 Elektronische Zentralelektrik
- 007 Codierung (Dienst 1A)
- Bordnetz-SG Codierung lang
- Byte 8-Bit-Muster x1xxxxx (x = die vorhandenen Werte im Eingabefeld übernehmen, dazu Eingabemodus (BIN) einschalten!)
- mit OK bestätigen!

GB

**Please effect coding as follows:**

- Vehicle self-diagnosis
- Gateway assembly list
- 19-diagnosis interface for data bus
- 007-Coding (service \$1A) \ Read / write long coding
- 69-trailer function (switch to coded!)

**Vehicles with park assist systems****The automatic deactivation of the rear park assist system in trailer operation will be effected by means of the subsequent coding of the park assist control unit:**

- Vehicle self-diagnosis
- Gateway assembly list
- 10-park assist system II / parallel park assist
- 008 Coding (service \$22)
- Byte 0-bit pattern xxxxxx1 (x = accept the default values in the input field for this purpose activate input mode (BIN) !)
- confirm with OK !

**NOTE:**

**If the vehicle's rear fog lamp does not switch off automatically in trailer mode the following code must be entered in addition to the aforementioned configuration of the central electrical system:**

**Vehicle self-diagnosis**

- 09 Electronic central electrical system
- 007 Coding (service 1A)
- Vehicle's electrical system controller coding long
- Byte 8-bit pattern x1xxxxx (x = accept the default values in the input field for this purpose activate input mode (BIN) !)
- confirm with OK !

F

**Veillez effectuer le codage comme il suit:**

- autodiagnostic du véhicule
- liste d'assemblage gateway
- 19-interface de diagnostic pour bus de données
- 007-codage (service \$1A) \ lire / écrire un code long
- 69-mode remorque ( commuter à encodé!)

**Véhicules avec système d'aide au parking****L'aide au parking arrière est désactivée automatiquement dans le mode remorque par le codage suivant du dispositif de commande du système d'aide au parking:**

- autodiagnostic du véhicule
- liste d'assemblage gateway
- 10-système d'aide au parking II / parallel park assist
- 008 Codage (service \$22)
- Modèle Byte 0 bits xxxxxx1 (x = reprendre les valeurs dans le champ de saisie et allumer le mode saisie (BIN)!)
- Confirmer en appuyant sur OK







**AVERTISSEMENT:**







**Si le feu brouillard arrière monté sur le véhicule ne s'éteint pas automatiquement durant le fonctionnement avec remorque, il faut compléter la configuration ci-dessus en codant l'électricité centrale comme suit:**

**autodiagnostic du véhicule**

- 09 Électricité centrale électronique
- 007 Codage (service 1A)
- Codage dispositif de commande circuit de bord long
- Modèle Byte 8 bits x1xxxxx (x = reprendre les valeurs dans le champ de saisie et allumer le mode saisie (BIN)!)
- Confirmer en appuyant sur OK!

I	E	NL
<p><b>Si prega di eseguire la codifica come segue:</b></p> <ul style="list-style-type: none"> <li>- Autodiagnosi del veicolo</li> <li>- Lista del Gateway</li> <li>- 19-Interfaccia di diagnosi per il data bus</li> <li>- 007-codifica (servizio \$1A) \ Lettura e scrittura di codici lunghi</li> <li>- 69-Funzione rimorchio (commutare su codificato!)</li> </ul> <p><b>Veicoli con sensori di parcheggio</b></p> <p><b>La disattivazione automatica dei sensori di parcheggio posteriori quando è attaccato un rimorchio si ottiene attraverso la seguente programmazione della centralina di controllo dei sensori:</b></p> <ul style="list-style-type: none"> <li>- Autodiagnosi del veicolo</li> <li>- Lista del Gateway</li> <li>- 10 sensori di parcheggio II / parallel park assist</li> <li>- 008 Codifica (servizio \$22)</li> <li>- Byte 0-modello Bit xxxxxx1 (x = applicare i valori disponibili nel campo di immissione, attivando il modo di immissione (BIN)!)</li> <li>- Confermare con OK!</li> </ul> <p><b>AVVERTENZA:</b></p> <p><b>Se il retronebbia del veicolo non dovesse spegnersi automaticamente nell'esercizio con rimorchio, oltre alla configurazione indicata sopra, è necessario codificare l'impianto elettrico centrale come segue:</b></p> <p><b>Autodiagnosi del veicolo</b></p> <ul style="list-style-type: none"> <li>- 09 Impianto elettrico centrale elettronico</li> <li>- 007 Codifica (servizio 1A)</li> <li>- Codifica centralina rete di bordo lunga</li> <li>- Byte 8-modello Bit x1xxxxx (x = applicare i valori disponibili nel campo di immissione, attivando il modo di immissione (BIN)!)</li> <li>- Confermare con OK!</li> </ul>	<p><b>Codificar del siguiente modo:</b></p> <ul style="list-style-type: none"> <li>- Autodiagnóstico del vehículo</li> <li>- Lista Gateway</li> <li>- 19-Interfaz de diagnóstico para bus de datos</li> <li>- 007-Codificación (servicio \$1A) \ Leer / escribir la codificación larga</li> <li>- 69 Función del remolque (codificación)</li> </ul> <p><b>Vehículos con sistema de ayuda para el aparcamiento</b></p> <p><b>En vehículos con sistema de ayuda para el aparcamiento (PDC) se debe codificar la unidad de control PDC del siguiente modo:</b></p> <ul style="list-style-type: none"> <li>- Autodiagnóstico vehículo</li> <li>- Lista Gateway</li> <li>- 10-ayuda al aparcamiento II / parallel park assist</li> <li>- 008 Codificación (servicio \$22)</li> <li>- Byte tipo 0 bits xxxxxx1 (x = introducir los valores existentes en el campo de entrada, ¡activar al respecto el modo de introducción (BIN)!)</li> <li>- ¡Confirmar con OK!</li> </ul> <p><b>NOTA:</b></p> <p><b>En caso de que la luz antiniebla trasera del vehículo no se apague automáticamente en el servicio con remolque, deberá codificarse el sistema eléctrico central adicionalmente a la configuración arriba mencionada del siguiente modo:</b></p> <p><b>Autodiagnóstico vehículo</b></p> <ul style="list-style-type: none"> <li>- 09 Sistema eléctrico central electrónico</li> <li>- 007 Codificación (servicio 1A)</li> <li>- Sistema de alimentación de a bordo regulador codificación larga</li> <li>- Byte tipo 8 bits x1xxxxx (x = introducir los valores existentes en campo de entrada, ¡activar al respecto el modo de introducción (BIN)!)</li> <li>- ¡Confirmar con OK!</li> </ul>	<p><b>Gelieve codering als volgt door te voeren:</b></p> <ul style="list-style-type: none"> <li>- Eigen diagnose voertuig</li> <li>- Gateway-inbouwlijst</li> <li>- 19-diagnose-interface für gegenvensinvoerbus</li> <li>- 007-Codering (dienst \$1A) \ Lange codering lezen/schrijven</li> <li>- 69-aanhangwagenfunctie (op "Gecodeerd" schakelen!)</li> </ul> <p><b>Voertuigen met parkeerhulp</b></p> <p><b>Bij voertuigen met parkeerhulp dient de regeleenheid van de parkeerhulp als volgt te worden gecodeerd:</b></p> <ul style="list-style-type: none"> <li>- Eigen diagnose voertuig</li> <li>- Gateway-inbouwlijst</li> <li>- 10-parkeerhulp II / Park Assist</li> <li>- 008 Codering (dienst \$22)</li> <li>- Byte 0 - bitpatroon xxxxxx1 (x = de aanwezige waarden in het invoerveld overnemen, hiervoor invoermodus (BIN) inschakelen!)</li> <li>- met OK bevestigen!</li> </ul> <p><b>AANWIJZING!</b></p> <p><b>Mocht de mistlamp op het voertuig tijdens gebruik van de aanhanger niet automatisch worden uitgeschakeld, dan moet las aanvulling op de bovengenoemde configuratie de centrale elektrische installatie als volgt worden gecodeerd:</b></p> <p><b>Zelfdiagnose voertuig</b></p> <ul style="list-style-type: none"> <li>- 09 Elektronische centrale elektrische installatie</li> <li>- 007 Codering (dienst 1A)</li> <li>- Elektrische installatie-SG codering lang</li> <li>- Byte 8 - bitpatroon x1xxxxx (x = de aanwezige waarden in het invoerveld overnemen, dan invoermodus (BIN) inschakelen!)</li> <li>- Met OK bevestigen!</li> </ul>

D	GB	F
<p><b>Allgemein</b></p> <p>Nach Einbau des E-Satzes sind die obligatorische Anhängerbeleuchtung, die Gespannstabilisierung, sowie die in einigen Ländern gesetzlich vorgeschriebene Anhängerblinküberwachung ohne jede Freischaltung am Fahrzeug gewährleistet!</p> <p>Es wird jedoch die Meldung "Steuergerät falsch codiert" im Fehlerspeicher hinterlegt ( 19 - Diagnoseinterface für Datenbus)! Dieser Eintrag hat allerdings keine Auswirkung auf weitere Funktionen und kann bis zum nächsten planmäßigen Werkstattaufenthalt ignoriert werden. Wir empfehlen eine Freischaltung mittels herstellerseitigen Service-Testers im Rahmen der jährlichen Serviceintervalle!</p> <p><b>Codierung bitte wie folgt durchführen:</b></p> <ul style="list-style-type: none"> <li>- Fahrzeug-Eigendiagnose</li> <li>- 19-Diagnoseinterface für Datenbus</li> <li>- 007-Codierung (Dienst \$1A) \ Lange Codierung lesen / schreiben</li> <li>- 69-Anhängerfunktion ( auf codiert schalten!)</li> </ul> <p><b>Fahrzeuge mit Einparkhilfe:</b></p> <p>Die automatische Deaktivierung der rückwärtigen Einparkhilfe im Anhängerbetrieb wird durch nachfolgende Codierung des Einparkhilfe-Steuergeräts erreicht:</p> <ul style="list-style-type: none"> <li>- Fahrzeug-Eigendiagnose</li> <li>- 10-Einparkhilfe II</li> <li>- 009 Codierung</li> <li>- Master</li> <li>- 009.02 Klartextcodierung</li> <li>- Anhängersystem auswählen</li> <li>- mit OK bestätigen!</li> </ul> <p><b>Wichtige Hinweise:</b></p> <p><b>Fahrzeuge mit Start-Stopp-Automatik:</b></p> <p>Bei Anhängerbetrieb ist die Start-Stopp-Automatik deaktiviert!</p> <p><b>Gespannstabilisierung:</b></p> <p>Bei den meisten Fahrzeugen ab Modelljahr 2009 kann die automatische Aktivierung der Gespannstabilisierung wie folgt überprüft werden:</p> <ul style="list-style-type: none"> <li>- Anhänger elektrisch mit Fahrzeug verbinden</li> <li>- Nach dem Einschalten der Zündung leuchtet die Kontrollleuchte  zwei Sekunden länger als die Kontrollleuchte , (siehe auch Fahrzeughandbuch)!</li> </ul> <p><b>oder Auswertung über Fahrzeugdiagnose:</b></p> <ul style="list-style-type: none"> <li>- Anhänger elektrisch mit Fahrzeug verbinden</li> <li>- Fahrzeug-Eigendiagnose</li> <li>- 03 Bremsenelektronik</li> <li>- 011 Messwerte</li> <li>- "10" und "Q" eingeben</li> <li>- Anhänger ja</li> </ul>	<p><b>General</b></p> <p>After the installation of the electric kit, the obligatory trailer lighting, Towing vehicle and trailer stabilisation, as well as the trailer indicator control which is statutory in a several countries are guaranteed without having to make any connections on the vehicle!</p> <p>The message "Control unit incorrectly coded" will, however, appear in the fault memory ( 19 - Diagnosis interface for data bus)! Yet this entry has no effect on the other functions and can be ignored until your next regular service appointment. We recommend the connection via the factory-mounted service tester within the framework of the annual service intervals!</p> <p><b>Please effect coding as follows:</b></p> <ul style="list-style-type: none"> <li>- Vehicle self-diagnosis</li> <li>- 19-diagnosis interface for data bus</li> <li>- 007-Coding (service \$1A) \ Read / write long coding</li> <li>- 69-trailer function ( switch to coded!)</li> </ul> <p><b>Vehicles with park assist systems:</b></p> <p>The automatic deactivation of the rear park assist system in trailer operation will be effected by means of the subsequent coding of the park assist control unit:</p> <ul style="list-style-type: none"> <li>- Vehicle self-diagnosis</li> <li>- 10-park assist system II</li> <li>- 009 Coding</li> <li>- Master</li> <li>- 009.02 plain text coding</li> <li>- select trailer system</li> <li>- confirm with OK !</li> </ul> <p><b>NOTE:</b></p> <p><b>Vehicles with start-stop system:</b></p> <p>The start-stop system is deactivated in trailer mode!</p> <p><b>Towing vehicle and trailer stabilisation:</b></p> <p>In most vehicles as of model year 2009 the automatic activation the towing vehicle and trailer stabilization can be checked as follows:</p> <ul style="list-style-type: none"> <li>- Connect trailer to vehicle electrically</li> <li>- After the ignition has been turned on the control lamp  comes on two seconds longer than control lamp , (see also driver's manual)!</li> </ul> <p><b>or evaluation via vehicle diagnosis:</b></p> <ul style="list-style-type: none"> <li>- Connect trailer to vehicle electrically</li> <li>- Vehicle self-diagnosis</li> <li>- 03 Brake electronics</li> <li>- 011 Measured values</li> <li>- Enter "10" and "Q"</li> <li>- Trailer yes</li> </ul>	<p><b>Généralités</b></p> <p>Après l'installation du module électrique, l'éclairage obligatoire de la remorque, Stabilisation de l'attelage, ainsi que le contrôle des clignotants de la remorque, prescrit dans certains pays, sont assurés sans qu'il soit nécessaire d'activer ces fonctions dans le véhicule!</p> <p>Toutefois, le message «mauvais codage du dispositif de commande» sera affiché dans la mémoire d'erreurs ( 19 - interface de diagnostic pour bus de données)! Or, ce message n'a aucune influence sur les autres fonctions et il n'est pas nécessaire de s'en occuper jusqu'au prochain service prévu dans un garage. Nous vous recommandons d'activer ces fonctions à l'aide d'un testeur de service du fabricant dans le cadre des intervalles annuels de service!</p> <p><b>Veillez effectuer le codage comme il suit:</b></p> <ul style="list-style-type: none"> <li>- autodiagnostic du véhicule</li> <li>- 19-interface de diagnostic pour bus de données</li> <li>- 007-codage (service \$1A) \ lire / écrire un code long</li> <li>- 69-mode remorque ( commuter à encodé!)</li> </ul> <p><b>Véhicules avec système d'aide au parking:</b></p> <p>L'aide au parking arrière est désactivée automatiquement dans le mode remorque par le codage suivant du dispositif de commande du système d'aide au parking:</p> <ul style="list-style-type: none"> <li>- autodiagnostic du véhicule</li> <li>- 10-système d'aide au parking II</li> <li>- 009 Codage</li> <li>- Master</li> <li>- 009.02 Codage en langage clair</li> <li>- Sélectionner le système remorque</li> <li>- Confirmer en appuyant sur OK</li> </ul> <p><b>AVERTISSEMENT:</b></p> <p><b>Véhicules avec système automatique de démarrage et d'arrêt :</b></p> <p>Le système automatique de démarrage et d'arrêt est désactivé pendant le remorquage.</p> <p><b>Stabilisation de l'attelage :</b></p> <p>L'activation automatique de la stabilisation de l'attelage peut être vérifiée sur la plupart des véhicules construits à partir de 2009 de la manière suivante :</p> <ul style="list-style-type: none"> <li>- Relier le système électrique de la remorque à celui du véhicule</li> <li>- Une fois l'allumage en marche, le voyant  reste allumé deux secondes plus longtemps que le voyant , (cf. aussi le manuel du véhicule)!</li> </ul> <p><b>ou l'évaluation réalisée via le système de diagnostic du véhicule comme suit :</b></p> <ul style="list-style-type: none"> <li>- Relier le système électrique de la remorque à celui du véhicule</li> <li>- Auto-diagnostic du véhicule</li> <li>- 03 Système électronique de freinage</li> <li>- 011 Valeurs mesurées</li> <li>- Entrer «10» et «Q»</li> <li>- Remorque «Oui»</li> </ul>

I	E	NL
<p><b>Informazioni generali</b></p> <p>Dopo il montaggio del gruppo elettronico, l'illuminazione obbligatoria, Sistema di stabilizzazione rimorchio, e il controllo dei lampeggianti del rimorchio (prescritto dalla legge in alcuni paesi) sono assicurati senza bisogno di alcuna procedura di attivazione!</p> <p>Tuttavia, il messaggio di errore „Codifica del dispositivo di controllo non corretta“ è registrata nella memoria ( 19 – Interfaccia di diagnosi per il data bus)! Questa registrazione non ha comunque alcun effetto sulle ulteriori funzioni, e può essere ignorata fino alla prossima manutenzione periodica da eseguire in officina. Consigliamo di eseguire l'attivazione con il tester di servizio originale del costruttore nel quadro della manutenzione annuale!</p> <p><b>Si prega di eseguire la codifica come segue:</b></p> <ul style="list-style-type: none"> <li>- Autodiagnosi del veicolo</li> <li>- 19–Interfaccia di diagnosi per il data bus</li> <li>- 007-codifica (servizio \$1A) \ Lettura e scrittura di codici lunghi</li> <li>- 69–Funzione rimorchio (commutare su codificato!)</li> </ul> <p><b>Veicoli con sensori di parcheggio:</b></p> <p>La disattivazione automatica dei sensori di parcheggio posteriori quando è attaccato un rimorchio si ottiene attraverso la seguente programmazione della centralina di controllo dei sensori:</p> <ul style="list-style-type: none"> <li>- Autodiagnosi del veicolo</li> <li>- 10-sensori di parcheggio II</li> <li>- 009 Codifica</li> <li>- Padrone</li> <li>- 009.02 codifica testo</li> <li>- selezionare sistema rimorchio</li> <li>- Confermare con OK!</li> </ul> <p><b>AVVERTENZA:</b></p> <p><b>Veicoli con start-stop automatico:</b></p> <p>Nel funzionamento con rimorchio lo start-stop automatico è disattivato!</p> <p><b>Sistema di stabilizzazione rimorchio:</b> nella maggior parte dei veicoli a partire dall'anno modello 2009 si può verificare l'attivazione automatica del sistema di stabilizzazione rimorchio come segue:</p> <ul style="list-style-type: none"> <li>- collegare il rimorchio elettricamente con il veicolo</li> <li>- all'inserimento dell'accensione si accende la spia di controllo  due secondi di più rispetto alla spia di controllo  (vedi anche manuale del veicolo)!</li> </ul> <p><b>oppure elaborazione tramite il sistema di diagnosi dell'automezzo:</b></p> <ul style="list-style-type: none"> <li>- collegare il rimorchio elettricamente con il veicolo</li> <li>- autodiagnosi del veicolo</li> <li>- 03 elettronica dei freni</li> <li>- 011 valori di misura</li> <li>- digitare "10" e "Q"</li> <li>- rimorchio sì</li> </ul>	<p><b>Generales</b></p> <p>¡Después del montaje del equipo eléctrico queda asegurada la iluminación obligatoria del remolque, estabilización del tiro, así como el control de intermitentes del remolque prescritos por la ley en algunos países sin ninguna clase de activación en el vehículo!</p> <p>Sin embargo queda memorizado el mensaje “Codificación errónea del regulador” en la memoria de fallos ¡(19 – Interfaz de diagnóstico para bus de datos)! Este registro sin embargo, no tiene ningún efecto sobre las demás funciones y podrá ser ignorado hasta la próxima cita prevista en el taller.</p> <p>¡Recomendamos una activación por medio del comprobador de servicio del fabricante con motivo de los intervalos anuales de servicio!</p> <p><b>Codificar del siguiente modo:</b></p> <ul style="list-style-type: none"> <li>- Autodiagnóstico del vehículo</li> <li>- 19-Interfaz de diagnóstico para bus de datos</li> <li>- 007-Codificación (servicio \$1A) \ Leer / escribir la codificación larga</li> <li>- 69-Función del remolque (codificación)</li> </ul> <p><b>Vehículos con sistema de ayuda para el aparcamiento:</b></p> <p>En vehículos con sistema de ayuda para el aparcamiento (PDC) se debe codificar la unidad de control PDC del siguiente modo:</p> <ul style="list-style-type: none"> <li>- Autodiagnóstico vehículo</li> <li>- 10-ayuda al aparcamiento II</li> <li>- 009 Codificación</li> <li>- Maestro</li> <li>- 009.02 Codificación de texto</li> <li>- Remolque seleccione</li> <li>- ¡Confirmar con OK!</li> </ul> <p><b>NOTA:</b></p> <p><b>Vehículos con sistema automático de arranque y parada:</b></p> <p>¡En el servicio con remolque, el sistema automático de arranque y parada está desactivado!</p> <p><b>Estabilización del tiro:</b></p> <p>En la mayoría de los vehículos a partir del año de fabricación 2009 podrá comprobarse la activación automática de estabilización del tiro de la siguiente manera:</p> <ul style="list-style-type: none"> <li>- Establecer una conexión eléctrica entre el remolque y el vehículo</li> <li>- Después de encender el contacto, la lámpara piloto  se ilumina durante dos segundos más que la lámpara piloto , ¡véase también el manual del vehículo)!</li> </ul> <p><b>o evaluación por medio del diagnóstico del vehículo:</b></p> <ul style="list-style-type: none"> <li>- Establecer una conexión eléctrica entre el remolque y el vehículo</li> <li>- Autodiagnóstico del vehículo</li> <li>- 03 Sistema electrónico de frenos</li> <li>- 011 Valores medidos</li> <li>- Introducir "10" y "Q"</li> <li>- Remolque sí</li> </ul>	<p><b>Algemeen</b></p> <p>Na inbouw van de elektroset zijn de verplichte aanhangverlichting, Stabilisatie van de auto met aanhangwagen, en de in enkele landen wettelijk voorgeschreven knippercontrole van de aanhanger zonder enige vrijeschakeling op het voertuig gegarandeerd!</p> <p>De melding “Bedieningsapparaat foutief gecodeerd” wordt echter in het foutengeheugen achtergelaten (19 - diagnose-interface voor gegevensinvoerbus)! Deze invoer oefent weliswaar geen invloed op andere functies uit en kan tot het volgende geplande verblijf in de garage genegeerd worden. Wij raden een activering door middel van een servicetester vanwege de fabrikant in het kader van de jaarlijkse serviceintervallen aan!</p> <p><b>Gelieve codering als volgt door te voeren:</b></p> <ul style="list-style-type: none"> <li>- Eigen diagnose voertuig</li> <li>- 19–diagnose-interface für gegengensinvoerbus</li> <li>- 007-Codering (dienst \$1A) \ Lange codering lezen/schrijven</li> <li>- 69–aanhangwagenfunctie (op “Gecodeerd” schakelen!)</li> </ul> <p><b>Voertuigen met parkeerhulp:</b></p> <p>Bij voertuigen met parkeerhulp dient de regelenheid van de parkeerhulp als volgt te worden gecodeerd:</p> <ul style="list-style-type: none"> <li>- Eigen diagnose voertuig</li> <li>- 10-parkeerhulp II</li> <li>- 009 Codering</li> <li>- Meester</li> <li>- 009.02 Codering tekst</li> <li>- Selecteer aanhangwagen</li> <li>- met OK bevestigen!</li> </ul> <p><b>AANWIJZING:</b></p> <p><b>Voertuigen met automatische start/stop:</b></p> <p>In de modus “Aanhangwagen” is de automatische start/stop gedeactiveerd!</p> <p><b>Stabilisatie van de auto met aanhangwagen:</b></p> <p>Bij de meeste voertuigen vanaf modeljaar 2009 kann de automatische activering van de stabilisatie van de auto met aanhangwagen als volgt gecontroleerd worden:</p> <ul style="list-style-type: none"> <li>- Aanhangwagen elektrisch met voertuig verbinden</li> <li>- Na het inschakelen van de ontsteking is het controlelampje  twee seconden langer dan het controlelampje  verlicht, (zie ook voertuighandboek)!</li> </ul> <p><b>of analyse van de voertuigdiagnose:</b></p> <ul style="list-style-type: none"> <li>- Aanhangwagen elektrisch met voertuig verbinden</li> <li>- Eigen diagnose van het voertuig</li> <li>- 03 remelektronica</li> <li>- 011 meetwaarden</li> <li>- "10" en "Q" invoeren</li> <li>- Aanhangwagen ja</li> </ul>

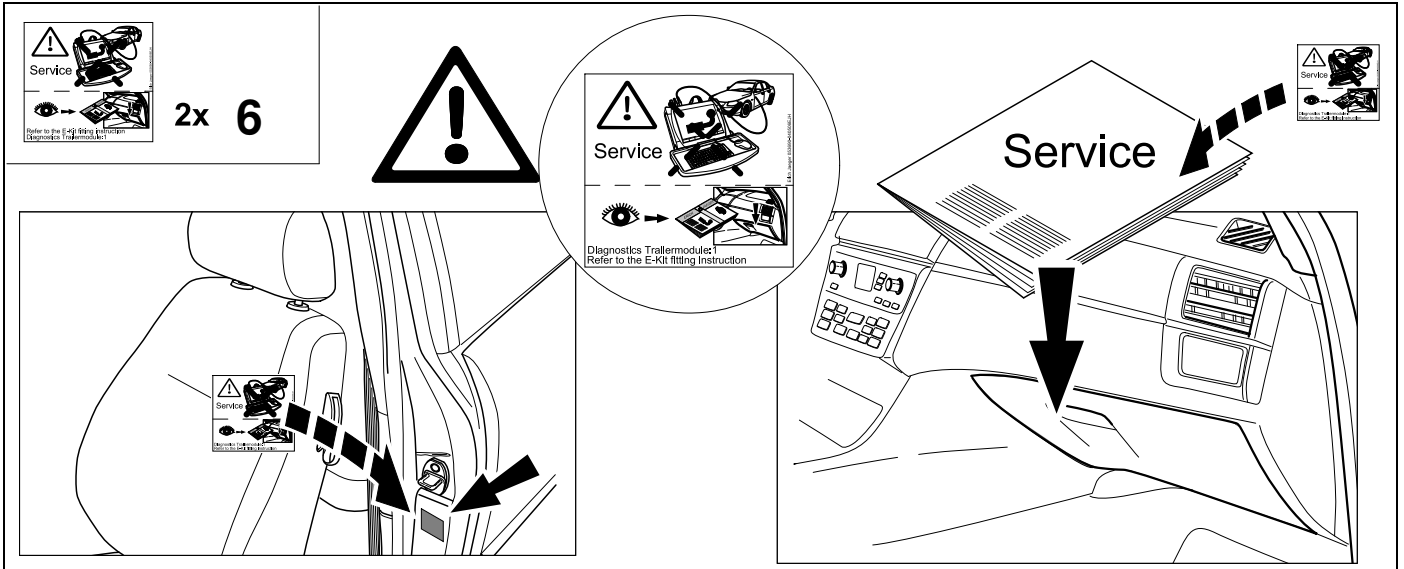

# Status LED für Eigendiagnose

# Status LED for self-diagnosis

## Operation support

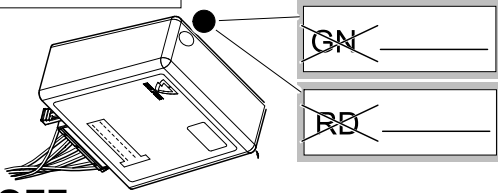
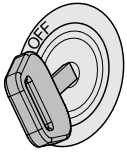

No CAN-Data =



Standby / Sleepmode



Ignition OFF

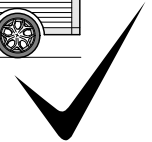
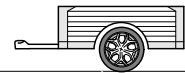
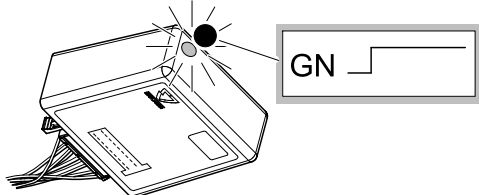

Ignition ON

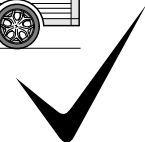
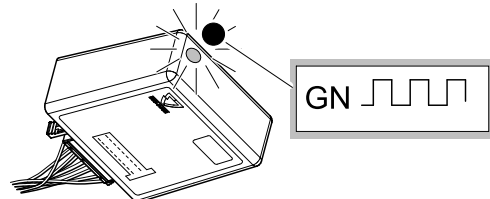

Ignition ON

## Failure support

CAN-Data Wire



1x max. 5 min.

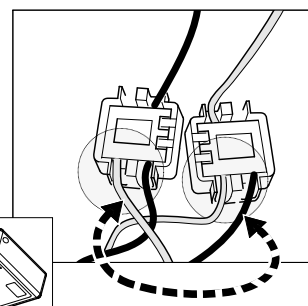
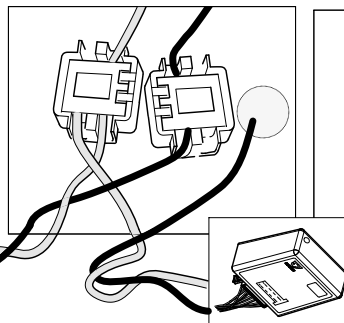
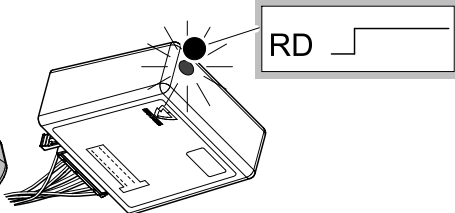

Ignition ON

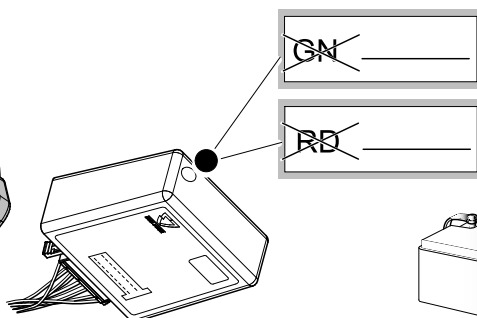
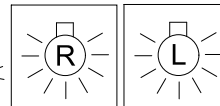

PIN 17 oder / or



PIN 1

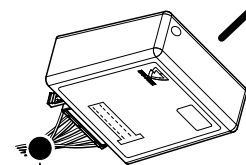
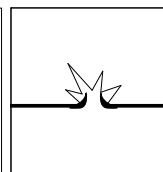
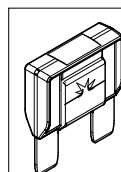
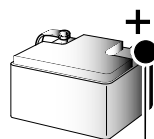

Ignition ON









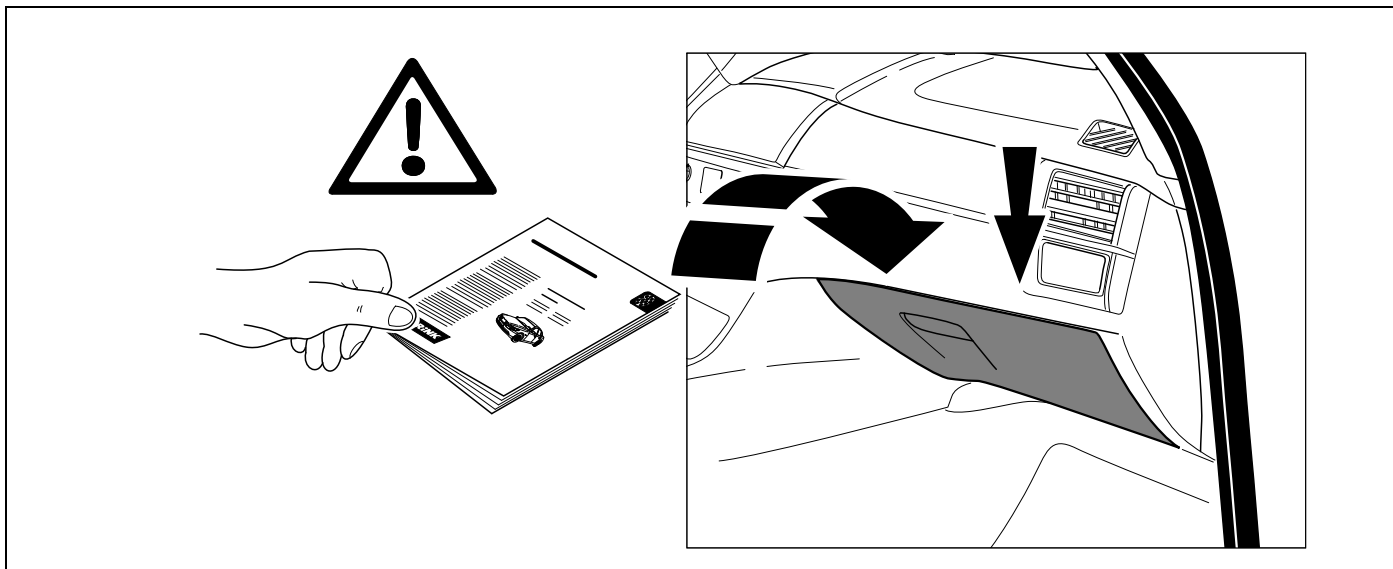

<p><b>(D)</b> Änderungen bezüglich Konstruktion, Ausstattung Farbe sowie Irrtum vorbehalten. Angaben und Abbildungen unverbindlich</p>	<p><b>(PL)</b> Zastrzega się prawo do zmian dot. konstrukcji, wykończenia, kolorystyki oraz pomyłek. Dane i ilustracje niewiążące.</p>
<p><b>(GB)</b> Subject to change in terms of construction, equipment and colour, and may contain errors. The information and illustrations are non-binding.</p>	<p><b>(TR)</b> Tasarım, donanım ve renk bakımından değişiklik yapma hakkı ve hata ve eksiklik mahfuzdur. Veriler ve resimler bağlayıcı değildir.</p>
<p><b>(F)</b> Sous réserve de modifications de la construction, de équipement, de la couleur et sous réserve d'erreurs. Les indications et les illustrations sont sans engagement.</p>	<p><b>(H)</b> A szerkezet, a kivitelt és a szín változtatása, valamint a változások joga fenntartva. Az adatok és az ábrák nem kötelező érvényűek.</p>
<p><b>(NL)</b> Wijzigingen met betrekking tot constructie, uitvoering en kleur evenals vergissingen voorbehouden. Gegevens en afbeeldingen niet bindend.</p>	<p><b>(HR)</b> Pravo promjena u svezi konstrukcije, opreme, boje kao i zabune oridžavamo. Podaci i ilustracije su neobavezne.</p>
<p><b>(DK)</b> Ændringer med hensyn til konstruktion, udstyr, farver samt fejl forbeholdes. Oplysninger og illustrationer er uforpligtende.</p>	<p><b>(BUL)</b> Запазени права по отношение на конструкцията, обзавеждането, цвета и грешки. Данните и изображенията не са обвързващи.</p>
<p><b>(N)</b> Endringer angående konstruksjon, utstyr, farge og feiltagelse forbeholdes. Opplysninger og illustrasjoner uforbindtlig.</p>	<p><b>(RO)</b> Ne rezervăm dreptul unor modificări ale construcției, dotării, culorii și dreptul la erori Datele indicate și imaginile sunt orientative.</p>
<p><b>(S)</b> Med reservation för ändringar vad det gäller konstruktion, utrustning, färg samt för misstag. Uppgifterna och bilderna är inte bindande.</p>	<p><b>(RU)</b> Права на внесение изменений относительно конструкции, оснащения, окраски, а также на ошибки сохраняются. Данные и иллюстрации имеют примерный характер.</p>
<p><b>(FIN)</b> Pidätämme oikeuden rakennetta, varustusta, väriä koskeviin sekä erehdyksestä johtuviin muutoksiin. Tiedot ja kuvat eivät ole sitovia.</p>	<p><b>(LT)</b> Pasiliekaama konstrukcijos, įrangos bei reikmenų, spalvos pakeitimų ir klaidų teisė. Duomenys ir iliustracijos neįpareigojantys.</p>
<p><b>(I)</b> Con riserva di modifiche relative a progettazione, dotazione, colore ed errori. Le indicazioni e figure sono fornite senza impegno.</p>	<p><b>(LV)</b> Tiek paturētas tiesības uz konstrukcijas, iekārtu, krāsu izmaiņām, kā arī kļūdīšanās. Dati un attēli bez saistībām.</p>
<p><b>(E)</b> Reservadas las modificaciones respecto a diseño, equipamiento, color, así como error. Indicaciones y figuras sin compromiso.</p>	<p><b>(EST)</b> Konstruktsiooni, varustuse ja võevi osas muudatused ning eksimine lubatud. Andmed ja joonised on mittesiduvad.</p>
<p><b>(P)</b> Reservamos o direito de alterações relativamente ao desenho, equipamento, cor, bem como de erro. Os dados e as gravuras não implicam compromisso da nossa parte.</p>	<p><b>(SLO)</b> Zadržana pravica do sprememb glede konstrukcije, opreme, barve ter pomote. Podatki in slike so neobvezne.</p>
<p><b>(GR)</b> Διατηρώνουμε κάθε επιφύλαξη ως προς αλλαγές σε σχέση με κατασκευή, εξοπλισμό, διαρρύθμιση, χρωματισμούς και λάθη παραδρομής.</p>	<p><b>(SK)</b> Zmeny, ktoré sa týkajú konštrukcie, vybavenia, farby, ako aj omyly sú vyhradené. Údaje a zobrazenia sú nezáväzné.</p>
<p><b>(CZ)</b> Změny, týkající se konstrukce, vybavení, barvy, jakož i omyly jsou vyhrazeny. Údaje a vyobrazení jsou nezáväzné.</p>	