

metelli

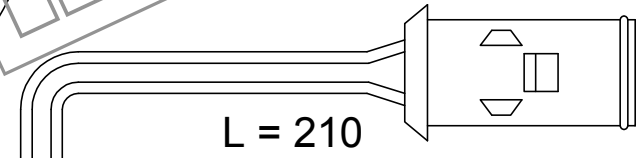

L = 210

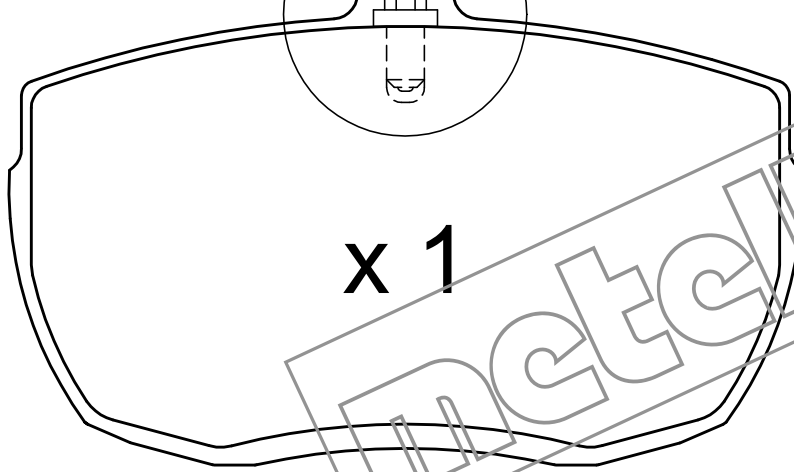
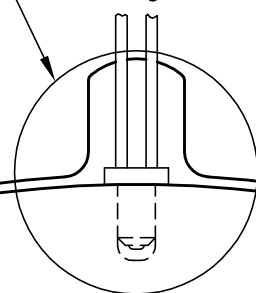

x 1

metelli

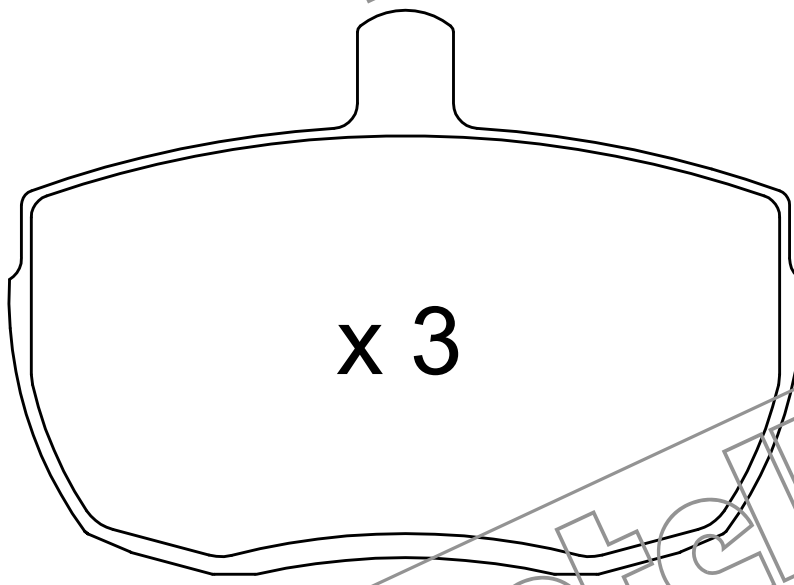
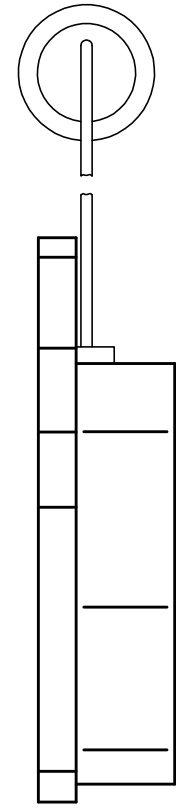

x 3

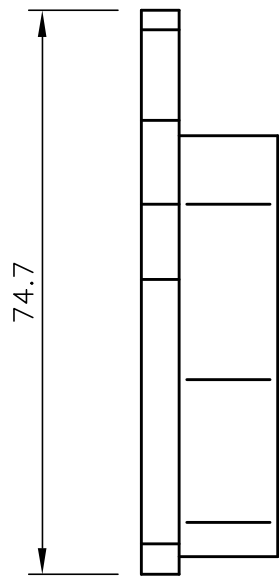

74.7

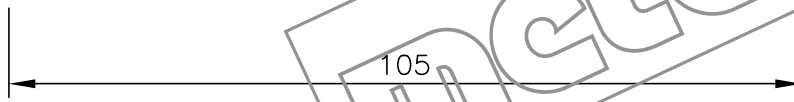

105

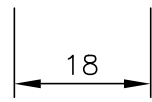

18

metelli