

L = 215

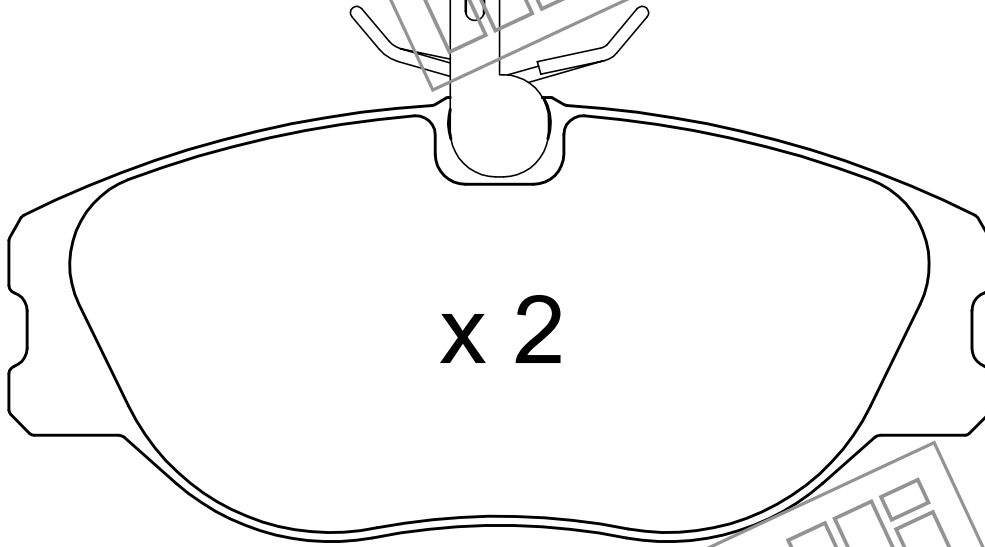

x 2

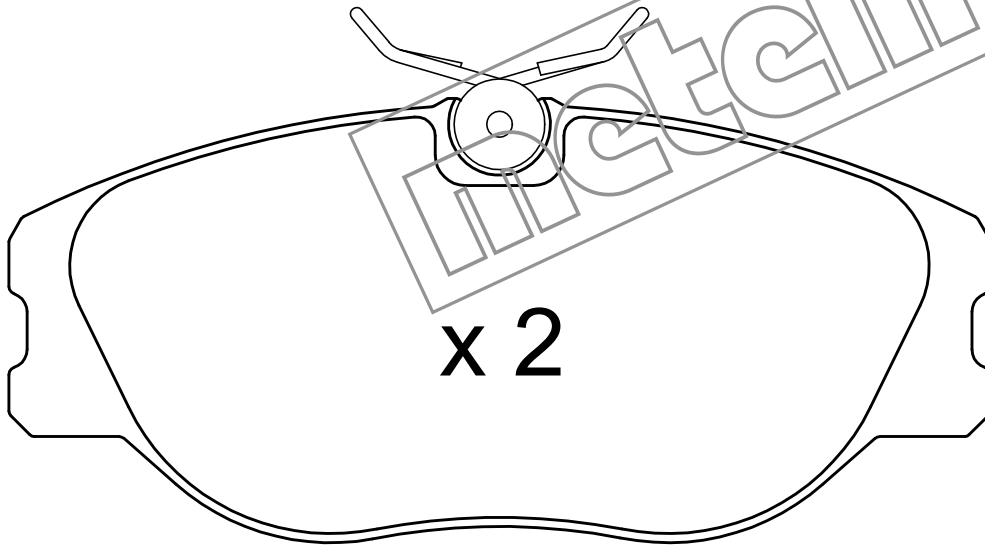

x 2

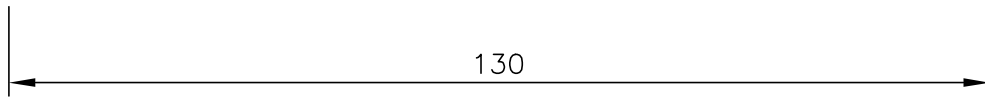

130

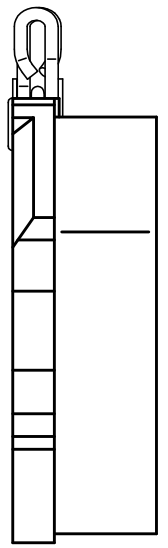
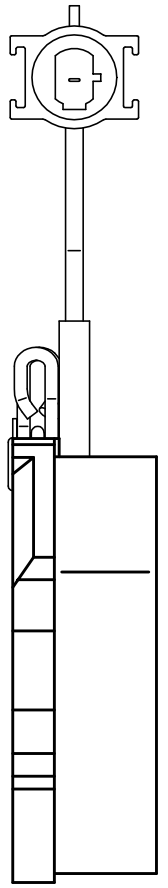

58.9

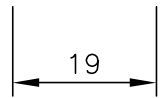

19

