

x 4

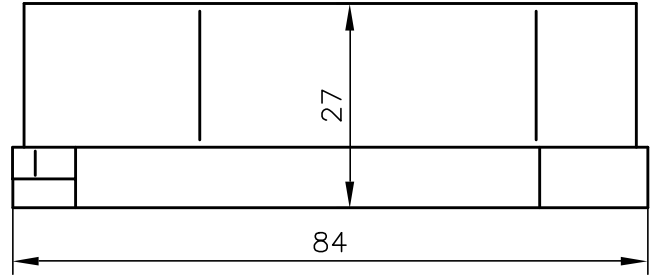

x 2

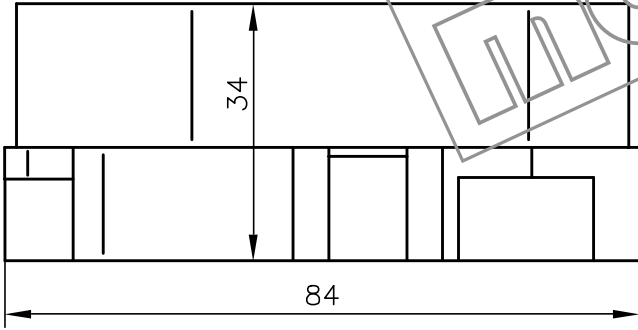
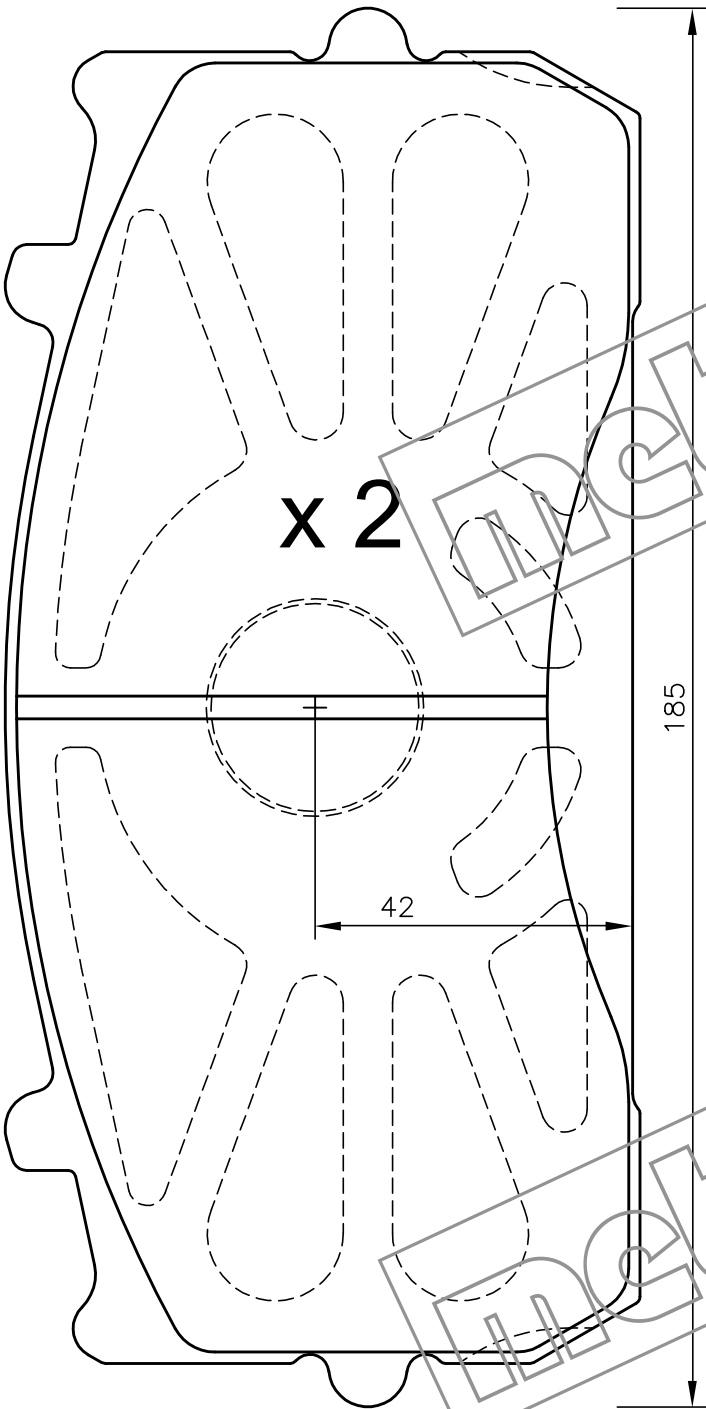

x 2

