

x 2

L = 315

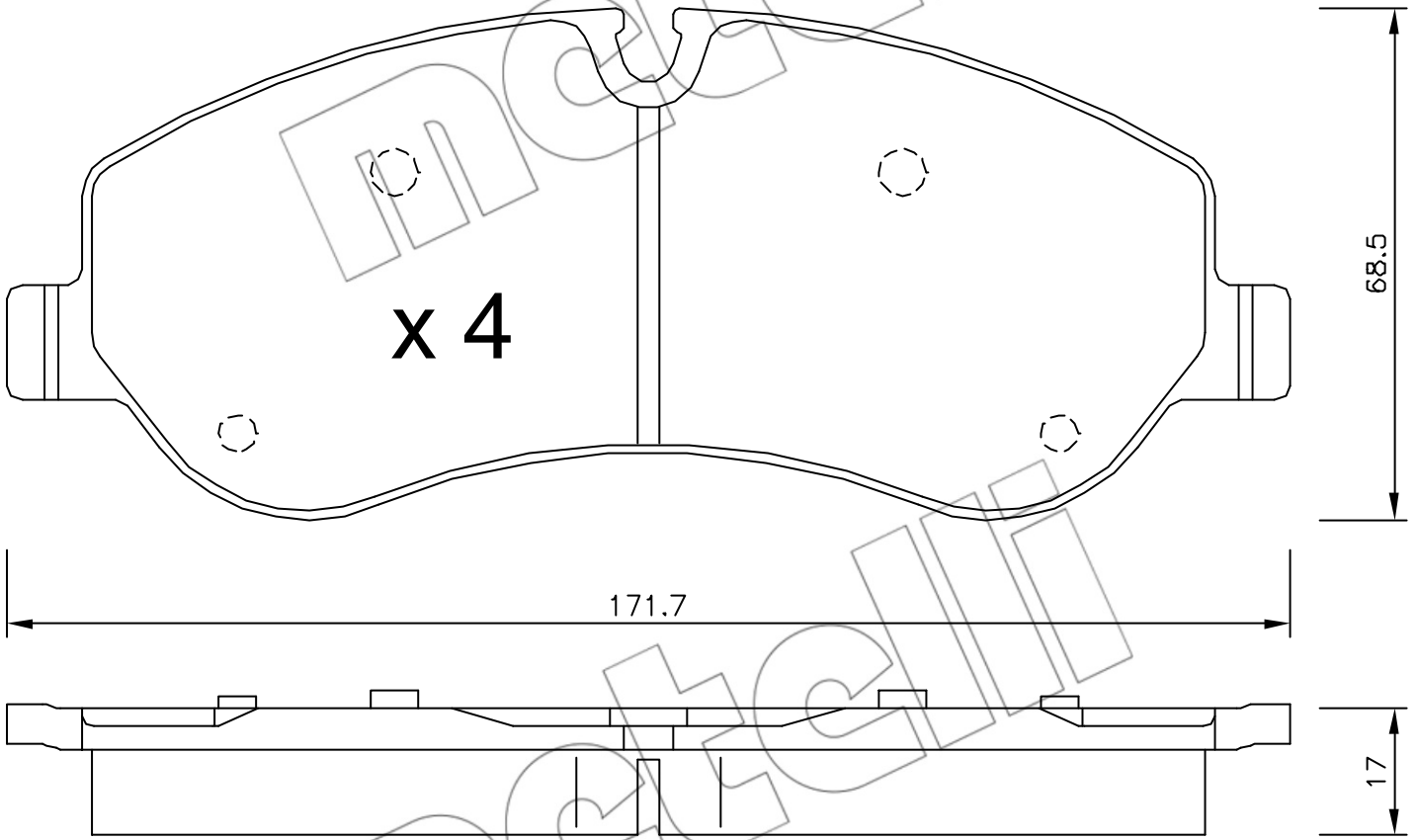

x 4

171.7

68.5

17

metelli