

x 1

L = 290

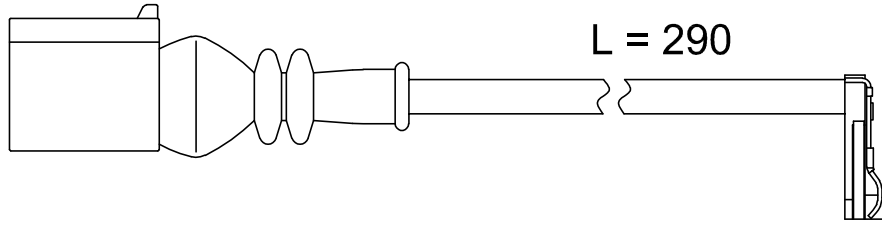

x 4

69.4

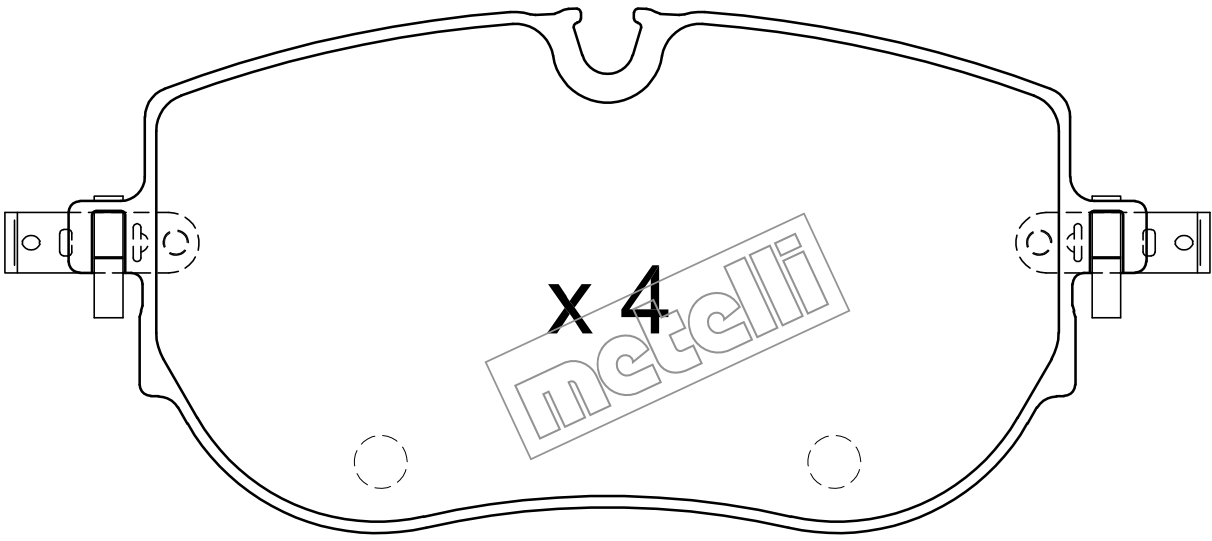

142.6

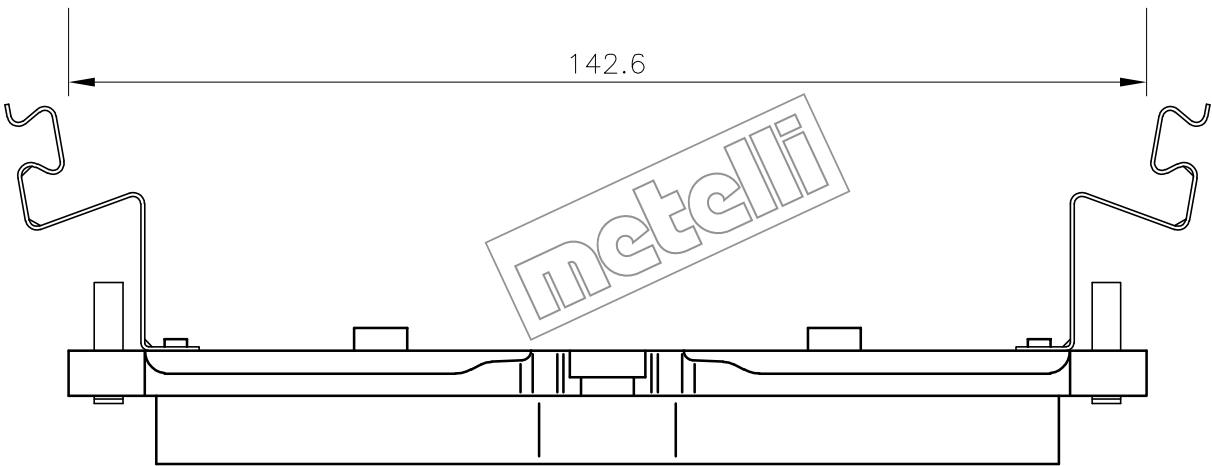

15

metelli