

L = 155

x 2

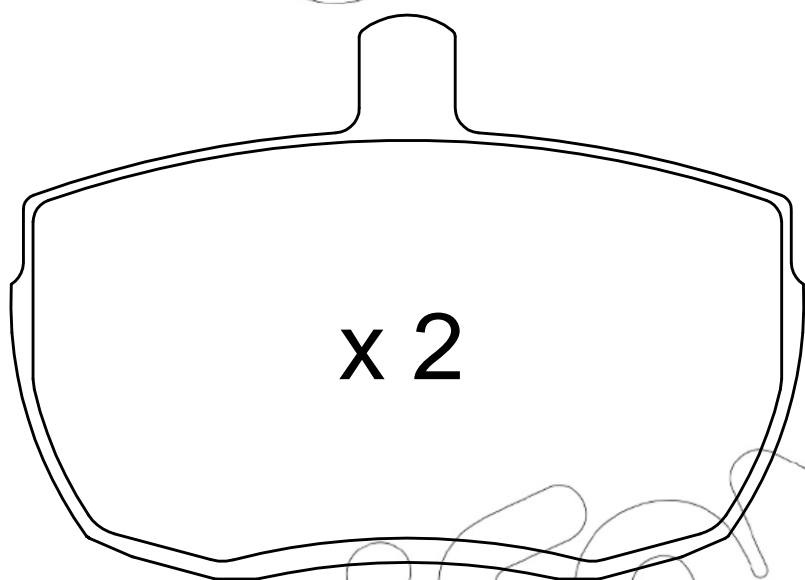

x 2

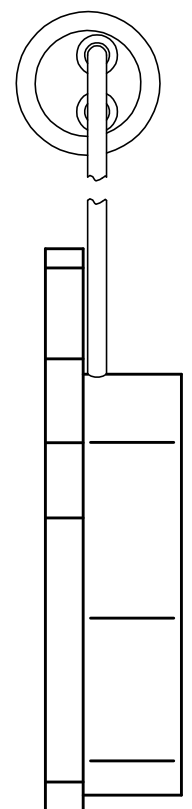
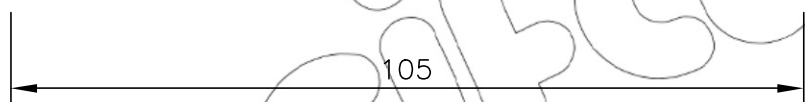

105

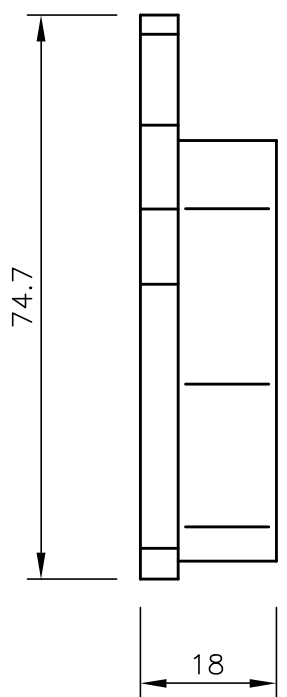

74.7

18