

x 2 L = 210

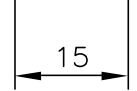
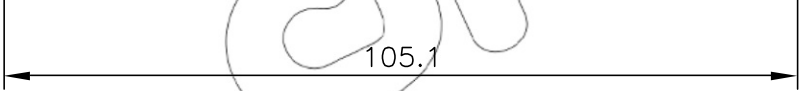
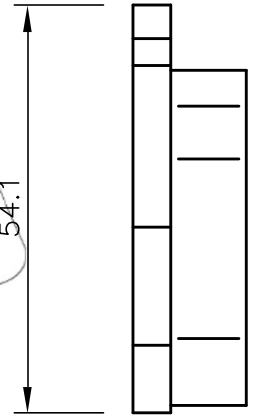
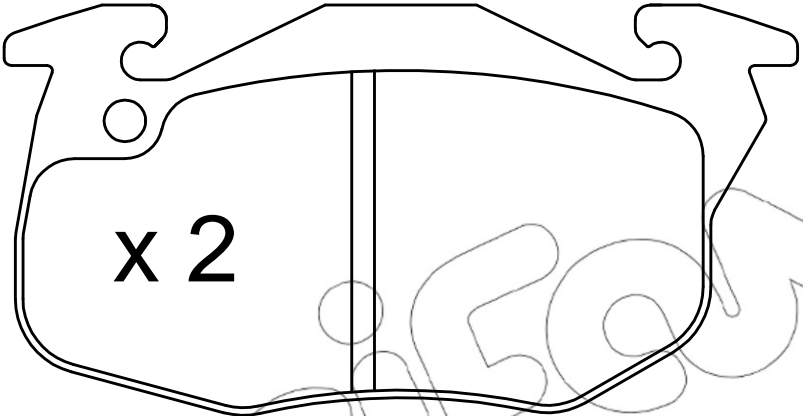
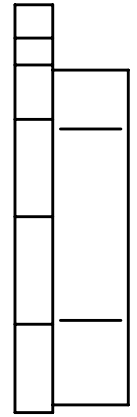
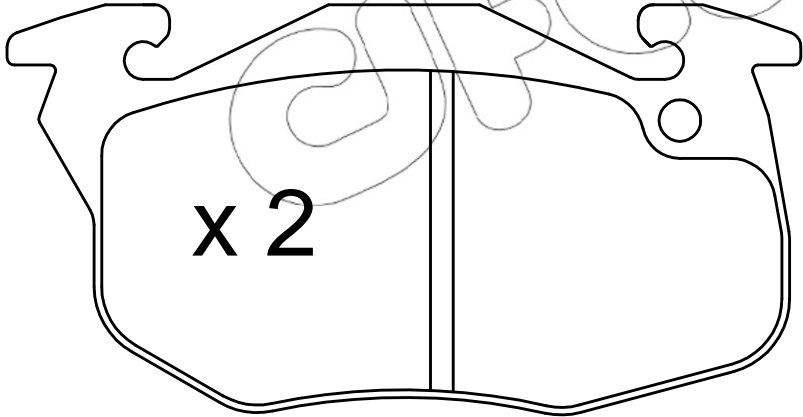

ifom