

**x 8**

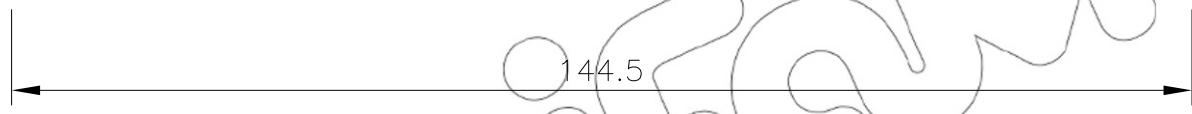
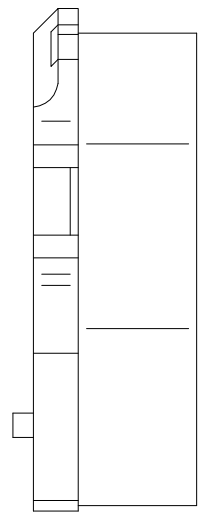
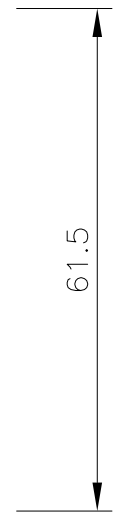
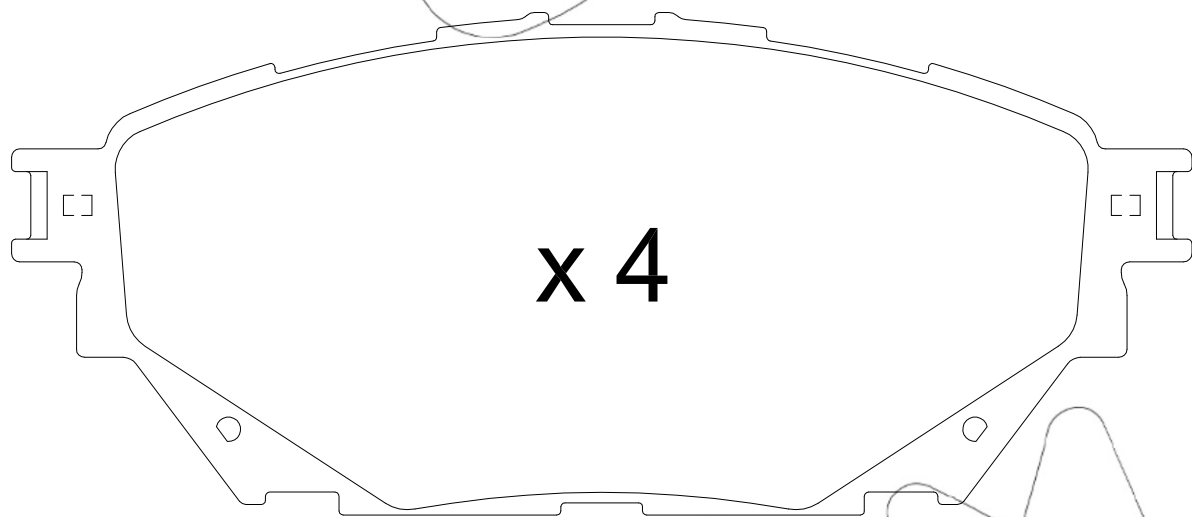
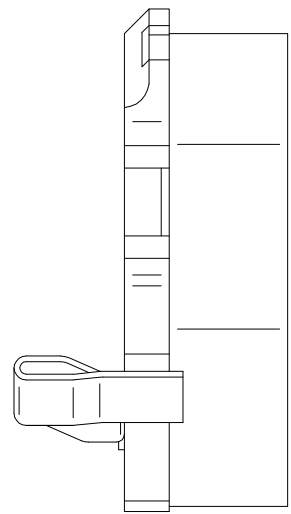
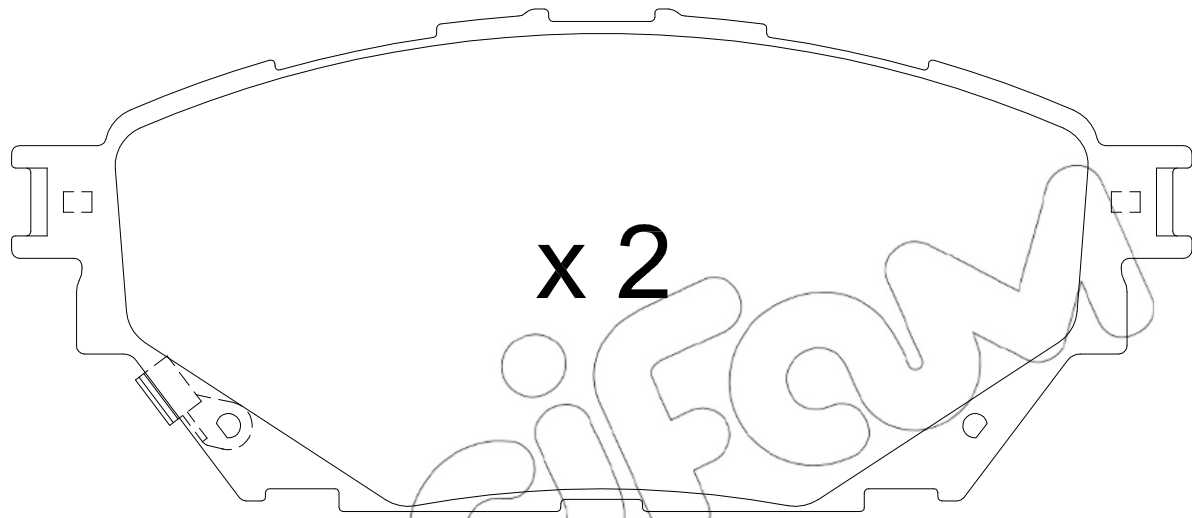
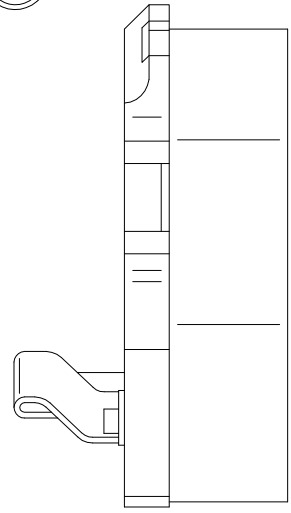

dfcm