

Blue Print ADBP550005

To fit:
various makes and models



EN

Fitting tool for elastic auxiliary belts

Removal and installation instructions for multi-V belt tool set

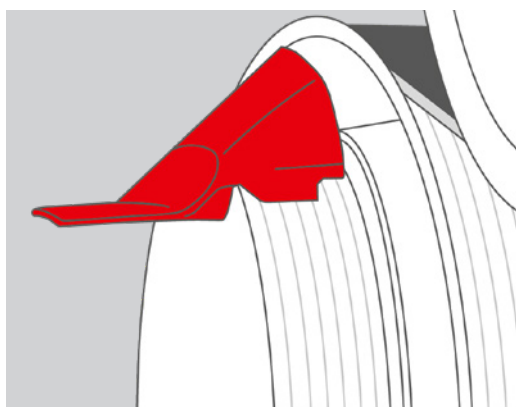

Removal

Removal tool on pulley

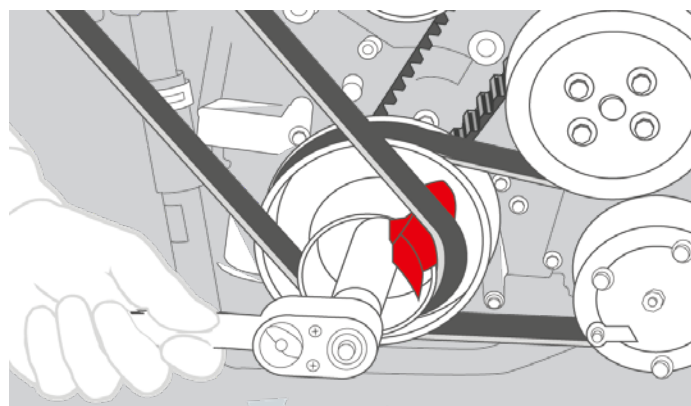
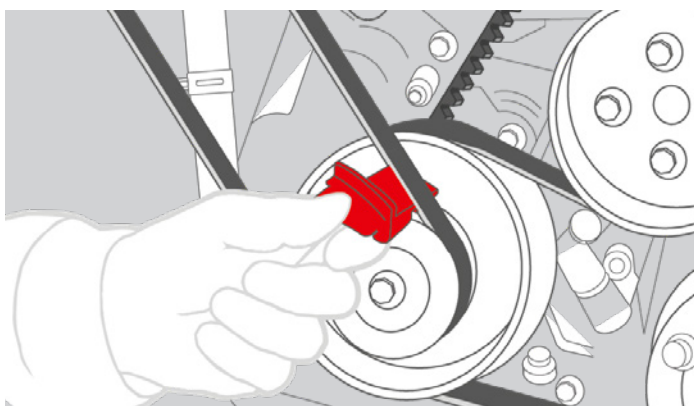

1. Position the removal tool between the pulley and the belts, as shown.

2. Use a ratchet to turn the crankshaft in a clockwise direction. The belt can then be lifted off the pulley, and slid off the tool.

For more technical information please visit: partsfinder.bilsteingroup.com

Blue Print ADBP550005

To fit:
various makes and models



EN

Fitting tool for elastic auxiliary belts

Removal and installation instructions for multi-V belt tool set

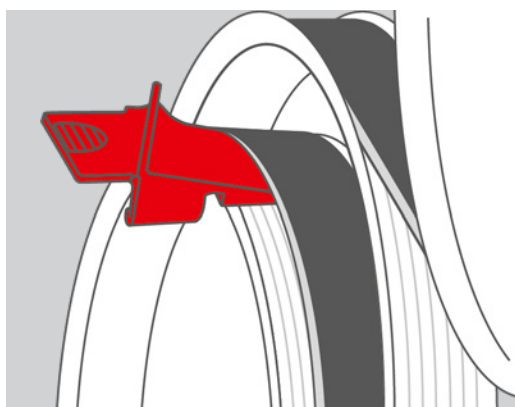

Installation

Installation tool on the pulley: position the belt on the accessory-drive pulley (i.e. A/C compressor, P/S pump, Alt.)

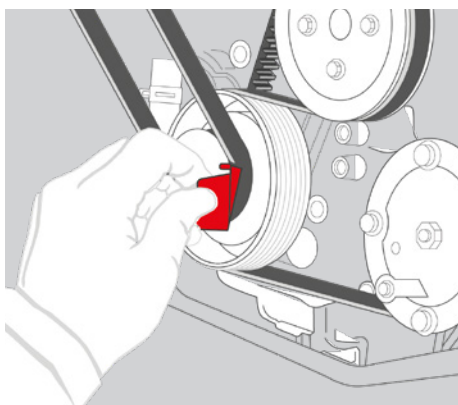

1. Place the installation tool over the crankshaft pulley and pass the belt over the leading edge of the tool.

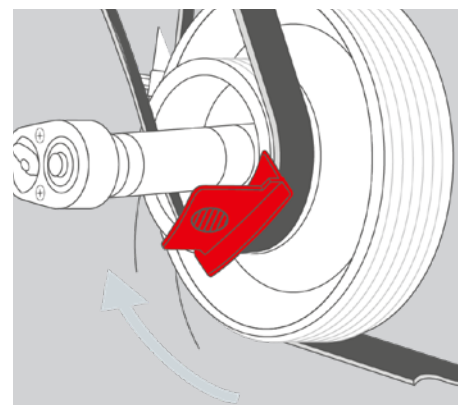
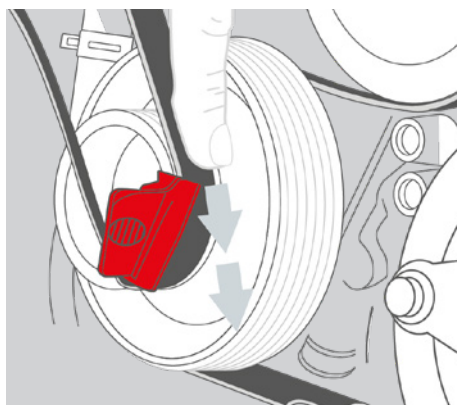

2. Use a ratchet to turn the crankshaft in a clockwise direction in order to install the elastic belt.

For more technical information please visit: partsfinder.bilsteingroup.com