

**Einbauanleitung Elektrosatz
Anhängervorrichtung mit 12-N Steckdose
lt. DIN/ISO Norm 1724**

**Instructions de montage du faisceau
électrique pour crochet d'attelage
conforme à la norme
DIN/ISO 1724 prise 12-N**

**Fitting instructions electric wiringkit
towbar with 12-N socket up to
DIN/ISO norm 1724**

**Montage-handleiding elektrokabelset voor
trekhaak met 12-N contactdoos
vlgs. DIN/ISO norm 1724**

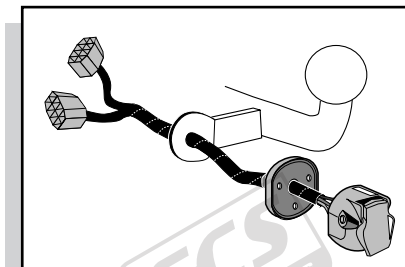

AUDI A3 HB 1996- +2001-

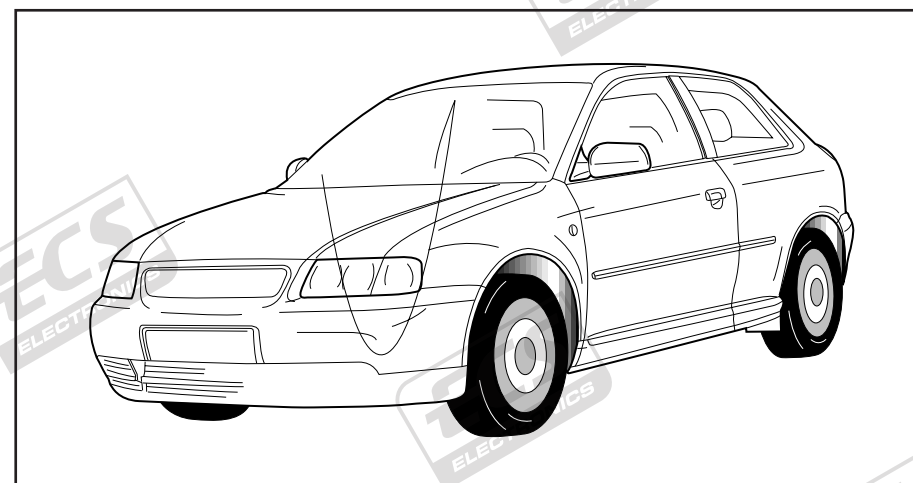

Bestel Nr.: VAG-041-B

* Teilliste

* Liste de pieces

* Part list

* Onderdelenlijst

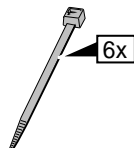
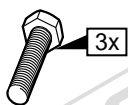
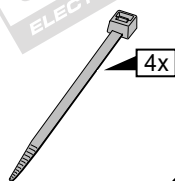
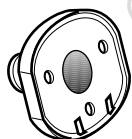
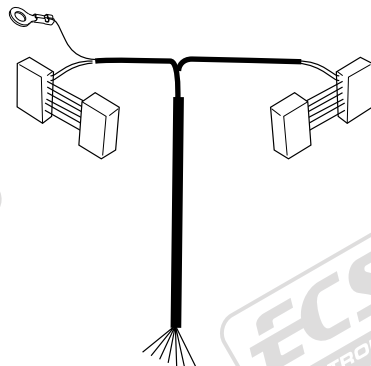
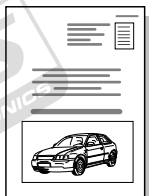
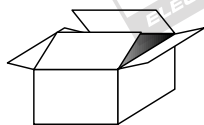

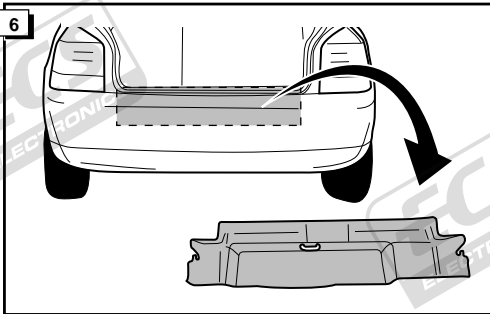
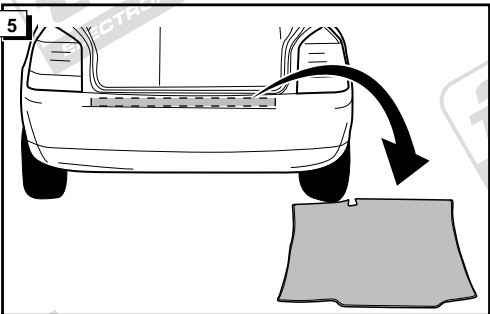
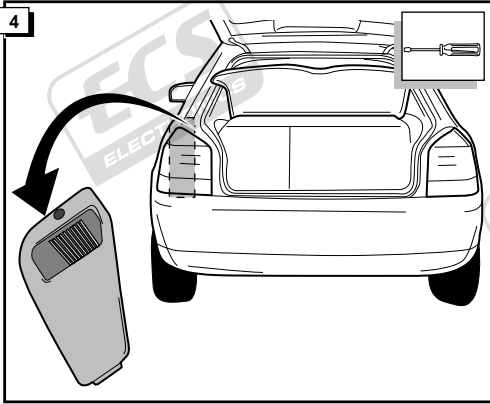
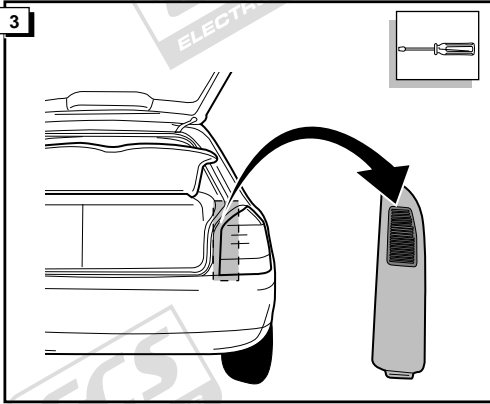
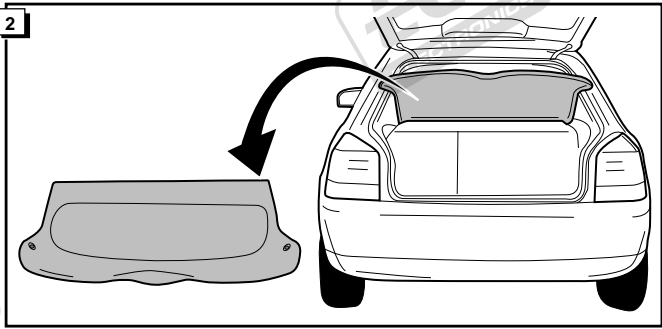
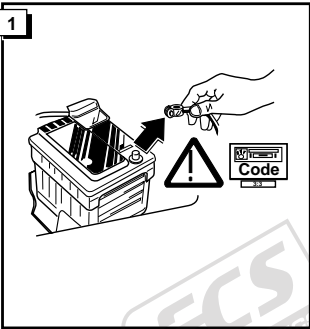
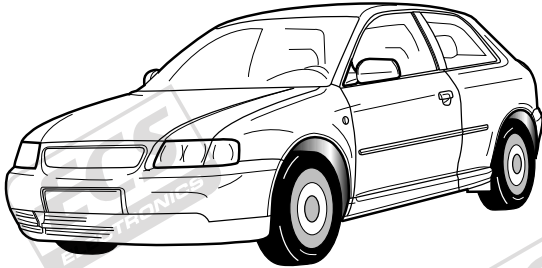

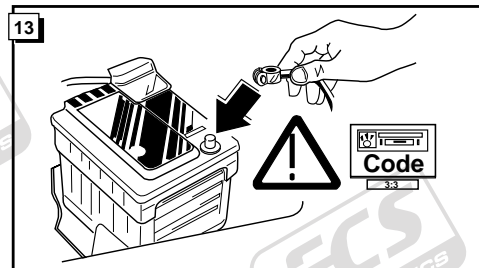
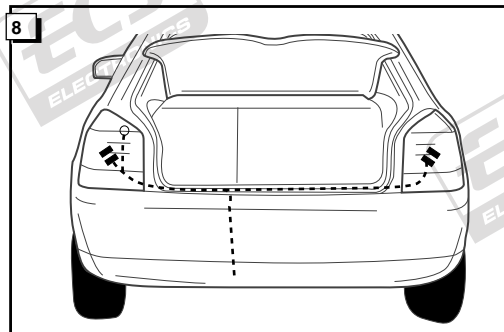
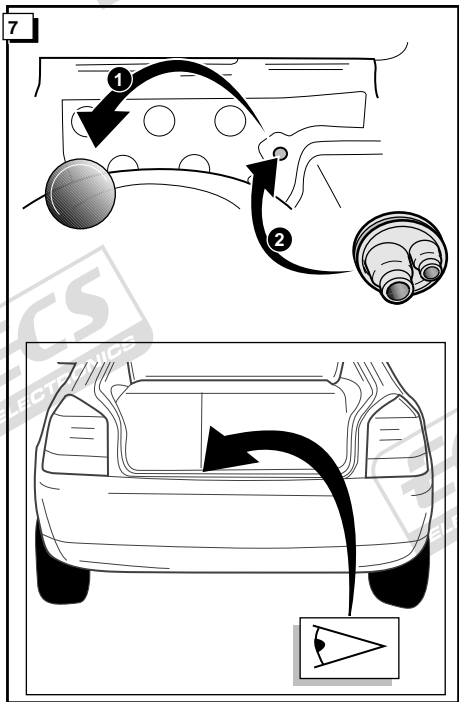

14

CONTROLEER FUNCTIES !
CHECK FUNCTIONS !
FUNKTIONEN KONTROLIEREN !
CONTRÔLER LES FONCTIONS !

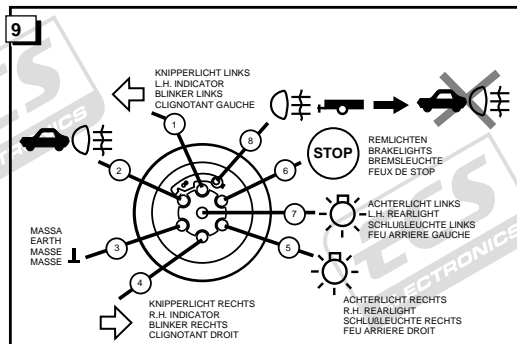
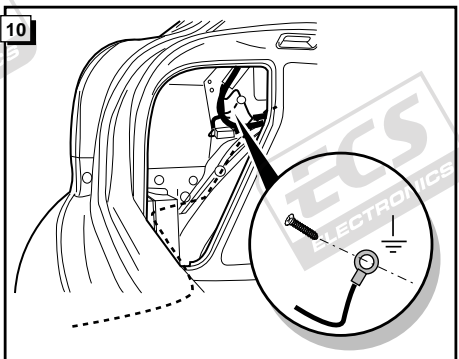

	NL	GB	D	FR
1 = L	GEEL	YELLOW	GELB	JAUNE
2 = 54-G	BLAUW	BLUE	BLAU	BLEU
3 = 31	WIT	WHITE	WEIß	BLANC
4 = R	GROEN	GREEN	GRÜN	VERT
5 = 58-R	BRUIN	BROWN	BRAUN	MARRON
6 = 54	ROOD	RED	ROT	ROUGE
7 = 58-L	ZWART	BLACK	SCHWARZ	NOIR
8 = 58-b	GRIJS	GREY	GRAU	GRIS

