

# HAZET-WERK

HÖCHSTE TECHNOLOGIE IN DER WERKZEUGFERTIGUNG SEIT 1868  
HIGHEST TECHNOLOGY IN TOOL MANUFACTURE SINCE 1868



## 4900-2A



**Sicherheits-Federspanner**  
**Safety Spring Vice**  
**Compresseur de ressort**  
**Compresor y desmonta muelles**  
**Tendimolle**





<i>de</i>	.....	<b>11...15</b>
<i>en</i>	.....	<b>16...19</b>
<i>fr</i>	.....	<b>20...23</b>
<i>es</i>	.....	<b>24...27</b>
<i>it</i>	.....	<b>28...31</b>

Ursprungssprache deutsch – original language: German – Langue d’origine: allemand  
Idioma de origen: alemán – Lingua originale: tedesco

**HAZET-WERK** Hermann Zerver GmbH & Co. KG

 Güldenwerther Bahnhofstraße 25 - 29 · 42857 Remscheid · GERMANY

 10 04 61 · 42804 Remscheid · GERMANY ·  +49 (0) 21 91 / 7 92-0



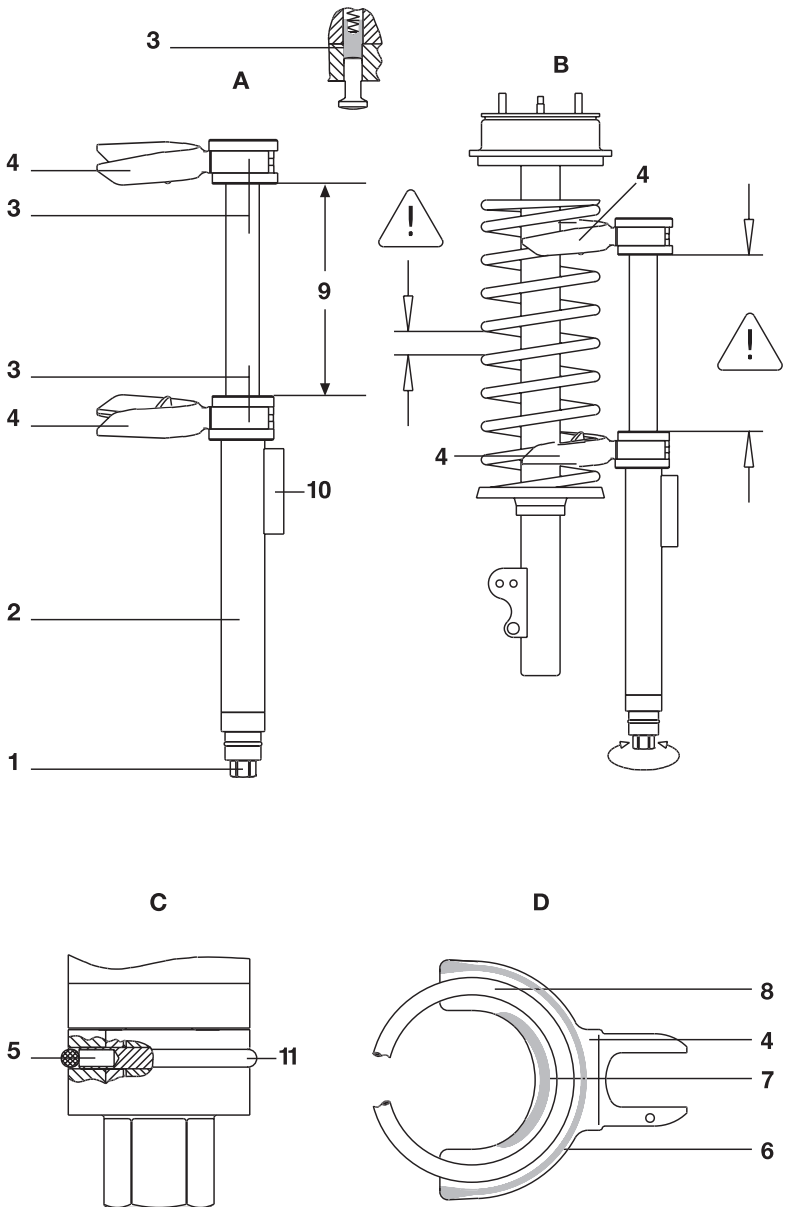

 **FAX** +49 (0) 21 91 / 7 92-375 ·  [www.hazet.de](http://www.hazet.de) ·  **e-mail** [info@hazet.de](mailto:info@hazet.de)





		HAZET No.			HAZET No.		
<b>ALFA ROMEO</b>							
Alfa 147	2003	4900-11 (2x)			4900-11 (2x)		
Alfa 156	1998-2003	4900-10 (2x)		*	*		*
Mito	2009	4900-11 (2x)			4900-11 (2x)		
<b>AUDI</b>							
A2	2000	4900-11 (2x)		*	*		*
A3	2000-	4900-11 (2x)		*	4900-10 (2x)		*
A4	1996	4900-11 (2x)		*	*		*
A5	2007-	4900-12 (2x)		*	*		*
A6	1996	4900-11 (2x)		*	*		*
A8	1996	4900-11 (2x)		*	*		*
<b>BMW</b>							
1 (E87) **: 116i / 118i / 120i / 118d / 120d	2004-	4900-11 (2x)		4900-110 (2x)	4902/6		-
3 (E46) **	1998-	4900-22 24		4900-220 240	*		-
3 (E90) **: 320i / 325i / 330i / 320d Limousine	2004-	4900-22 24		4900-243	4902/6		-
3 (E91) **: 320 / 325 / 330 / Touring	2005-	4900-22 24		4900-243	4902/6		-
3 (E92): 320 / 323 / 325 / 328 / 330 / 335	2005-	4900-22 24		4900-243			
3 (E93): 320 / 325 / 328 / 330 / 335	2006-	4900-22 24		4900-243			
5 (E39) **: 528i	1995-2000	4900-12 (2x)		4900-120 (2x)	*		*
5 (E60) **	2004-	4900-22 24		4900-220	*		*
7 (E38) **	1993-2000	4900-23 (2x)		4900-230 (2x)	*		*
7 (E65) **: 735i / 745i / 730d / 740d	2001-	4900-23 (2x)		4900-231 (2x)	4900-19 (2x)		4900-190 (2x)
7 (E66) **: 735Li / 745Li	2001-	4900-23 (2x)		4900-231 (2x)	4900-19 (2x)		4900-190 (2x)
E46, 318ti Compact	2001-	4900-12 (2x)					
Mini	2001	4900-11 (2x)			4900-10 11		
X3 (E83)	2006-	4900-31 33					
X5 (E70)	2006	4900-10 11		4900-100 110			
Z3 **	1996-	4900-12 (2x)		4900-120 (2x)	*		*

		HAZET No.			HAZET No.		
----------------------------------------------------------------------------------	-----------------------------------------------------------------------------------	--------------	-----------------------------------------------------------------------------------	-----------------------------------------------------------------------------------	--------------	-----------------------------------------------------------------------------------	------------------------------------------------------------------------------------

### CHRYSLER

300M (LH)	1998-2001	4900-12 (2x)		*	4900-11 (2x)		*
Jeep Wrangler (TJ)	1997-2006	4900-11 (2x)		*	*		*
Stratus (JA/JX)	1996-2001	4900-16 (2x)		*	*		*
Voyager (GS)	1996-2000	4900-13 (2x)		*	*		*











### CITROEN

Jumper	1997-2002	4900-13 (2x)		*	*		*
Nemo	2008	4900-11 (2x)			4900-11 (2x)		



















### DACIA

Logan 1,6i	2005-	4900-11 (2x)		*	*		*
------------	-------	--------------	-----------------------------------------------------------------------------------	---	---	--	---

### FIAT

500	2007-	4900-12 (2x)					
Doblo	2010	4900-11 (2x)			4900-11 (2x)		
Ducato	1995-2002	4900-13 (2x)		*	4900-13 (2x)		*
Ducato	2006	4900-13 (2x)					
Grande Punto	2005-	4900-11 (2x)		*	4900-11 (2x)		*
Qubo	2009	4900-12 (2x)			4900-12 (2x)		
Stilo	2002	4900-11 (2x)		*	*		*

### FORD

C-Max	2006	4900-12 (2x)					
Fiesta	2002-2005	4900-11 (2x)					
Fiesta	2005-2008	4900-11 (2x)					
Fiesta	2009-	4900-12 (2x)					
Focus	1998-2004	4900-11 (2x)		*	*		*
Focus	2004-2010	4900-12 (2x)			4900-10 (2x)		
Focus	2010-	4900-11 (2x)			4900-10 (2x)		
Fusion	2005	4900-11 (2x)					
Ka	1996-2008	4900-11 (2x)			4900-10 (2x)		
Mondeo	1996-2000	4900-12 (2x)		*	4900-11 12		*
Mondeo	2000-2007	4900-12 (2x)			4900-11 (2x)		
Mondeo	2008	4900-12 (2x)					
S-Max	2006	4900-11 (2x)					



### MERCEDES-BENZ















































A-Klasse Typ 168	1997–2004	4900-15A (2x)		*	4900-14A (2x)		*
A-Klasse Typ 169	2004–	4900-17 (2x)		*	4900-35 (2x)		*
Actros (MP-1) Nfz	1996–	Spezial-Anwendung: Führerhaus 4900-25 26 55					
Atego Nfz	1998–	Spezial-Anwendung: Führerhaus 4900-25 26 55					
B-Klasse Typ 245	2005	4900-17 (2x)			4900-35 (2x)		
C-Klasse / Typ 203	2000–	4900-17 18		4900-180	*		*
C-Klasse / Typ 204	2007–	4900-39/11 17		4900-393			
E-Klasse Typ 211 / Typ 219	2003–	4900-19 30		*	*		*
E-Klasse / Typ 212	2009–	4900-39/11 31		4900-395 310			
E-Klasse 4MATIC / Typ 210	1997–2002	4900-14A (2x)		*	*		*
E-Klasse/Typ 212 Sportfahrwerk	2009–	4900-39/11 17		4900-396			
GLK-Klasse/Typ X204	2008–	4900-39/11 17		4900-394 120			
ML-Klasse Typ 164	2005–	4900-35 (2x)		*	*		*
ML-Klasse / Typ 163	1997–2005	*		*	4900-16 (2x)		*
SLK / Typ 171	2004–	4900-18 34		4900-180	*		*
Vito, V-Klasse / Typ 638	1996–2002	4900-17 (2x)		*	*		*
Vito/Viano Typ 639	2003–	4900-23 (2x)		4900-230 (2x)	*		*

### NISSAN

Primera (P11)	1996–2002	4900-10 11		*	4900-10 (2x)		*
---------------	-----------	------------	--	---	--------------	--	---



























### OPEL

Astra F	1991–2000	4900-11 (2x)		*	*		*
Astra G	1998–2004	4900-11 (2x)		*	4900-11 (2x)		*
Astra H	2004–2010	4900-12 (2x)		*	*		*
Corsa B	1993–2000	4900-11 (2x)		*	*		*
Corsa D	2006	4900-11 (2x)			4900-10		
Meriva	2010–	4900-11 (2x)					

		HAZET No.			HAZET No.		
Omega B	1997–2003	4900-12 (2x)		*	*		*
Tigra	1994–2001	4900-11 (2x)		*	4900-11 (2x)		*
Vectra B	1995–2002	4900-12 (2x)		*	*		*
Vectra C	2002–2008	4900-12 (2x)		*	*		*
Zafira	1999–2003	4900-12 (2x)		*	*		*
Corsa C	2000–2006	4900-11 (2x)					
<b>PEUGEOT</b>							
106	1997–2003	4900-12 (2x)		*	*		*
307 SW	2002–2008	4900-11 (2x)			4900-12 (2x)		
406	1997–2004	4900-12 (2x)		*	*		*
806	1999–2002	4900-13 (2x)		*	4900-11 (2x)		*
Boxer	*	4900-13 (2x)		*	*		*
Partner	1996–2003	4900-12 (2x)			4900-12 (2x)		
Partner	2006–	4900-12 (2x)					
<b>PORSCHE</b>							
911 Carrera RS (Typ 993)	1995–	4900-16 (2x)		*	4900-14A (2x)		*
Boxster/Boxster S (Typ 986)	1996–2004	4900-15A 22		*	4900-11 (2x)		*
Boxster/Boxster S (Typ 987)	2004	4900-15A 22		*	4900-22 (2x)		*
Carrera 2 / 4 (Typ 997)	2004	4900-15A 22		*	4900-22 (2x)		*
Carrera 2 / 4 / Turbo (Typ 996)	1998–2004	4900-15A 22		*	4900-16 (2x)		*
Cayenne	2004–	4900-16 (2x)		*	4900-16 (2x)		*
Cayman	2006–	4900-15A 22		*	4900-22 (2x)		*
<b>RENAULT</b>							
Clio 2	2001	4900-11 (2x)					
Clio 3 1,5 dci	2005	4900-12 (2x)		4900-120 (2x)	*		*
Espace 2	2004	4900-13 (2x)			4900-13 (2x)		
Espace 2,0 turbo	2003	4900-17 (2x)		*	*		*
Kangoo 1,5	2004	4900-15A (2x)		*	*		*
Laguna 2,0 dci	2005–	4900-12 (2x)		*	4900-11 (2x)		*
Megane	1996–2002	4900-12 (2x)		*	*		*
Megane	2008–	4900-12 (2x)					

		HAZET No.			HAZET No.		
Megane 2 1,9dci	2003–2008	4900-12 (2x)		4900-120 (2x)	*		*
Modus 1,5dci	2005–	4900-12 (2x)		*	*		*
Safrane B544	1996–2000	4900-11 12					
Scenic 1,5dci	2005–	4900-12 (2x)		4900-120 (2x)	*		*
Traffic	2005	4900-11 (2x)			4900-11 (2x)		
Twingo	2007–	4900-11 (2x)		*	*		*
Twingo 1,2	1998–2007	4900-11 (2x)		*	*		*
<b>SAAB</b>							
93	2002	4900-12 (2x)			4900-12 (2x)		
<b>SEAT</b>							
Altea	2006	4900-11 (2x)					
Ibiza	2002	4900-11 (2x)		*	4900-10 (2x)		*
Ibiza	2006	4900-11 (2x)					
Leon	2002	4900-11 (2x)		*	4900-10 (2x)		*
<b>SKODA</b>							
Fabia	2001	4900-11 (2x)		*	*		*
Oktavia	1996–2000	4900-11 (2x)		*	*		*
Roomster	2007	4900-11 (2x)			4900-11 (2x)		
Superb	2002	4900-11 (2x)		*	*		*
<b>SMART</b>							
fortwo	2009	4900-10 (2x)					
<b>SUZUKI</b>							
Ignis	2000–2003	4900-10 (2x)		*	*		*
Wagon R+	2000–2006	4900-10 (2x)		*	*		*
<b>TOYOTA</b>							
Corolla	1997–2002	*			4900-11 12		
Picnic	1996–2001	4900-11 (2x)			*		
<b>VOLKSWAGEN</b>							
Amarok	2010	4900-11 (2x)					
Caddy	2006	4900-11 (2x)					
Golf 4	1997–2003	4900-11 (2x)			4900-10 (2x)		
Golf 5	2003–2008	4900-11 (2x)					
Golf 6	2008–2012	4900-11 (2x)					



		HAZET No.			HAZET No.		
Lupo	1998–2005	4900-11 (2x)			4900-10 (2x)		
Passat 3C	2010–	4900-11 (2x)			4900-10 (2x)		
Passat B4	1993–1997	4900-11 (2x)			4900-10 (2x)		
Passat B5	1996–2005	4900-11 (2x)					
Passat B6	2005–	4900-11 (2x)					
Polo	2001–2009	4900-11 (2x)			4900-11 (2x)		
Polo 9N	2006	4900-11 (2x)					
Sharan	1995–2010	*			4900-12 (2x)		
Sharan	2010–				4900-10 (2x)		
T5 (Transporter)	2003–	4900-13 (2x)					
Tiguan	2008	4900-11 (2x)					
Touran	2003–	4900-11 (2x)			4900-10 (2x)		
Touran	2010–	4900-11 (2x)					
<b>Volvo</b>							
S 80	1998–2003	4900-12 (2x)			4900-12 (2x)		

– = keine Federspanner notwendig.

\* = z. Zt. keine Informationen vorhanden.

\*\* = BMW-Schraubenfedern nur in Verbindung mit entspr. Kunststoffeinlagen verwenden.  
BMW-Vorschrift: Federspanner nur mit Handwerkzeugen betätigen.

– = no Spring Vice necessary.

\* = no information available at the moment.

\*\* = Only use BMW coil springs in combination with the corresponding plastic spring protection inserts.  
BMW-regulations: Use Spring Vice with manual tools only!

– = L'utilisation d'un compresseur de ressort n'est pas nécessaire.

\* = Pas d'information disponible actuellement.

\*\* = N'utilisez les ressorts hélicoïdaux BMW qu'en connexion avec les protections en plastique correspondants.  
Instructions de BMW: Utilisez les compresseurs de ressort avec des outils à main.

– = no es necesario utilizar un compresor y desmonta muelles.

\* = ninguna información disponible actualmente.

\*\* = Utilice solamente resortes helicoidales BMW en combinación con las cubetas de protección apropiadas.

Instrucción de BMW: Solamente utilizar el compresor y desmonta muelles con herramientas de manejo manual.

– = tendimolle non necessario.

\* = nessuna informazione attualmente disponibile.

\*\* = utilizzare molle ad elica BMW solo insieme ai relativi spessori in plastica.

Norma BMW: azionare il tendimolle soltanto con utensili manuali.

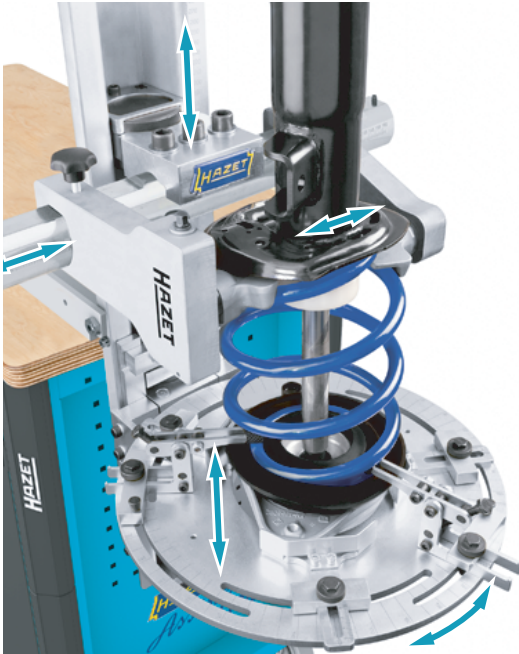

## **de** Erweiterung zum stationären Universal-Federspanner

Durch modulares System kann das Federspanner-Grundgerät 4900-2A mit den Komponenten zum stationären Universal-Federspanner 4903/4 ausgebaut werden.

## **en** Expansion to stationary universal spring vice.

With the components of the modular system the spring vice basic unit 4900-2A may be expanded to stationary universal spring vice 4903/4

## **fr** Extension au compresseur de ressort stationnaire universel

Grâce aux composants du système modulaire, l'appareil de base du compresseur de ressort 4900-2A peut être utilisé comme compresseur de ressort stationnaire universel 4903/4

## **es** Extensión al compresor y desmonta muelles universal, modelo estacionario

Gracias a los componentes del sistema modular, el aparato básico del compresor y desmonta muelles 4900-2A puede ser utilizado como compresor y desmonta muelles universal, modelo estacionario 4903/4

## **it** Estensione al tendimolle universale stazionario.

Grazie ad un sistema modulare il tendimolle/unità di base 4900-2A può essere esteso con i componenti al tendimolle universale stazionario 4903/4.

**HAZET**  
Youtube-CHANNEL

Anwendungsvideo  
Application video  
Vidéo d'utilisation  
Película aplicadora  
Video applicazione  
**4903/4**



[www.youtube.com/HAZETWERK](https://www.youtube.com/HAZETWERK)  
4903/4 Universal-Federspanner  
4903/4 Universal spring vice  
Compresseur de ressort universel  
Compresor y desmonta muelles universal  
Tendimolle universale



[www.hazet.de](http://www.hazet.de)

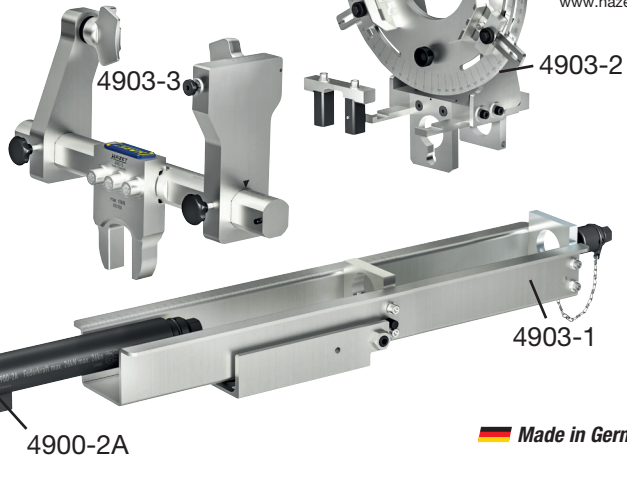

Made in Germany



## Bestimmungsgemäße Verwendung

Der Federspanner ist ausschließlich zum Spannen und Entspannen von Fahrwerksschraubenfedern im Kraftfahrzeugsbereich bestimmt. Gefährloses Arbeiten mit dem Federspanner ist nur gewährleistet, wenn Sie die Betriebsanleitung und die Arbeitshinweise vollständig lesen und die darin enthaltenen Anweisungen strikt befolgen. Bei Nichtbeachtung der Anweisungen besteht ernsthaftes bis tödliches Verletzungsrisiko! Bei weiteren Fragen zum Anwendungs- und Einsatzbereich, wenden Sie sich bitte telefonisch an unsere Anwendungstechnik unter der Rufnummer: 02191/792-0 oder schriftlich an: info@hazet.de. Für Personen- und Sachschäden, die infolge der Missachtung der Betriebsanleitung und der Arbeitshinweise auftreten, haftet die HAZET-WERK Hermann Zerver GmbH & Co. KG nicht!



Federspanner dürfen nur von ausgebildetem Fachpersonal bedient werden!

1. Vor jeder Benutzung ist der Federspanner auf seine volle Funktionsfähigkeit zu untersuchen. Ist die Funktionsfähigkeit nach dem Ergebnis dieser Untersuchung nicht gewährleistet oder werden Schäden festgestellt, darf der Federspanner nicht verwendet werden. Ist die volle Funktionsfähigkeit nicht gegeben und wird der Federspanner dennoch verwendet, besteht die Gefahr von erheblichen Körper-/Gesundheits- und Sachschäden bis hin zum tödlichen Verletzungsrisiko. Volle Funktionsfähigkeit ist gegeben, wenn
  - der O-Ring gleichmäßig an der Nut anliegt (bei fehlendem O-Ring kann der Scherstift herausgleiten);
  - die Aufnahmeleiste fest auf dem Rohr sitzt;
  - die Aufnahmeleiste arretiert ist;
  - das Gerät leichtgängig ist.
2. Beim Spannen der Feder ist darauf zu achten, dass sich die Federwindungen nicht berühren dürfen, ebensowenig die beiden Spannplatten gemäß Abb. Ziff. 4 (B), weil es sonst zu einer Überlastung und somit zum Bruch des Scherstifts kommen kann.

3. Die Federmittelachse muss immer parallel zum Grundgerät gemäß Abb. Ziff. 2 (A) sein. Dies gilt insbesondere bei konischen Federn. Anderenfalls ist der einwandfreie Sitz der Feder in der Spannplatte während des gesamten Spannvorgangs nicht gewährleistet.

4. Es dürfen nur geeignete Spannplatten gemäß Abb. Ziff. 4 (B) eingesetzt werden. Die Feder gemäß Abb. Ziff. 8 (D) muss sicher innerhalb der Außenrippe gemäß Abb. Ziff. 6 (D) und der Sicherheitsnase gemäß Abb. Ziff. 7 (D) liegen. Es ist darauf zu achten, daß ein Herausgleiten der Feder gemäß Abb. Ziff. 8 (D) aus den Spannplatten gemäß Abb. Ziff. 4 (A) nicht möglich ist.

5. Spannplatten dürfen nur paarweise eingesetzt oder ausgetauscht werden. Vor Spannbeginn ist das Spannplatten-Paar gemäß Abb. Ziff. 4 (A) aufzustecken und einzurasten. Dabei ist sicherzustellen, dass die Arretierungsbolzen gemäß Abb. Ziff. 3 (A) vollständig eingerastet sind. Anderenfalls kann es zum Herauspringen der Feder oder zum Herausgleiten der Spannplatten kommen. Hierdurch besteht Verletzungsgefahr.

6. Die Vornahme von Veränderungen an dem Federspanner ist aus Sicherheitsgründen strengstens untersagt. Ersetzen Sie insbesondere nicht den Scherstift gemäß Abb. Ziff. 5 (C) durch einen stärkeren Scherstift, da dann die Überlastsicherung nicht mehr gegeben ist und es zu einer Überlastung des Geräts kommen kann.

7. Federspanner nie ohne Bedienungsanleitung an Dritte weitergeben!

8. Vor und während des Spannvorganges und nach jedem Transport (Ortsveränderung) ist die richtige Lage der Feder in der dafür vorgesehenen Einrichtung zu kontrollieren.

## Gerätekenwerte

### MacPherson Federspanner

Grundgeräte:	4900-2A
Max. Spannkraft	26 KN
Max. Antriebsmoment:	250 Nm
Max. Länge:	809 mm
Spannweg:	309 mm
Gewicht o. Spannplatten:	8,4 kg
Ersatzteilsatz:	4900-02A/3
Antrieb DIN 475	mm s 27 mm/Umdr. 3
Prüftemperatur / Einsatzbereich RT	-20° bis +40° C

## Geräteelemente

- 1 Antriebsmutter
- 2 Spannkörper
- 3 Arretierungsbolzen
- 4 Spannplatten
- 5 Sicherheits-Scherstift
- 6 Außenrippe
- 7 Sicherheitsnase
- 8 Feder
- 9 Spannweg
- 10 Aufnahmeleiste
- 11 O-Ring

## Grundmodell und Zubehör

### Spannplatten

Art.-Nr.	d <sub>1</sub>	d <sub>2</sub>
4900-10	69,0	120,0
4900-11	107,0	151,0
4900-12	121,0	173,0
4900-13	146,0	207,5
4900-14A	81,0	114,0
4900-15A	111,5	152,5
4900-16	80,5	119,5
4900-17	124,0	175,0
4900-18	145,0	186,0
4900-19	80,5	119,5
4900-22	126,0	173,0
4900-23	152,0	207,5
4900-24	140,0	154,0
4900-25	47,0	77,0
4900-26	47,0	77,0
4900-30	80,0	146,0
4900-31	136,0	189,5
4900-33	136,0	189,5
4900-35	95,0	130,0

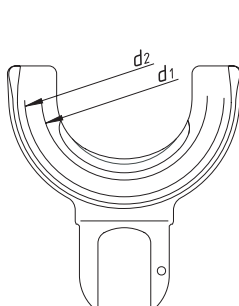

4900-10 bis 4900-23

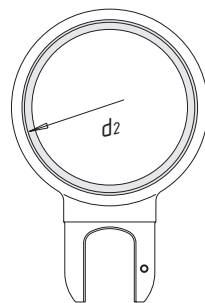

4900-24

### Spannplatte mit Bremse für MERCEDES-BENZ

4900-39/11

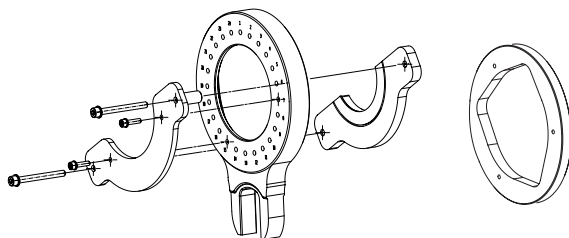

4900-39/11

4900-393 bis 4900-396

### Zentrier-Einsatz für MERCEDES-BENZ

4900-39/11

4900-393	95,0	130,0
4900-394	95,0	130,0
4900-395	95,0	130,0
4900-396	95,0	130,0

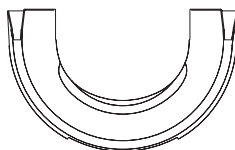

4900-100 bis 4900-231

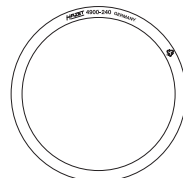

4900-240

### Kunststoffeinlagen

- 4900-100
- 4900-110
- 4900-120
- 4900-130
- 4900-180
- 4900-190
- 4900-220
- 4900-230
- 4900-231
- 4900-243
- 4900-310

### Sicherheits-Scherstift Ersatzteilsatz

4900-02A/3



4900-02A/3

## Sicherheits-Scherstift

Der Sicherheits-Federspanner ist gegen Überlastung mit einem Sicherheits-Scherstift ausgestattet, Überlastung der Spindel wird verhindert!

1. Antrieb von der Spindel trennen (mittels Hilfswerkzeug Schraube M 10 x 30). Wenn notwendig sind Scherstellen zu entgraten.

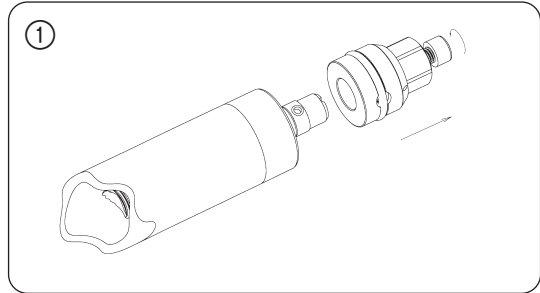

2. und 3. O-Ring und Scherstift-Bruchstücke entfernen.

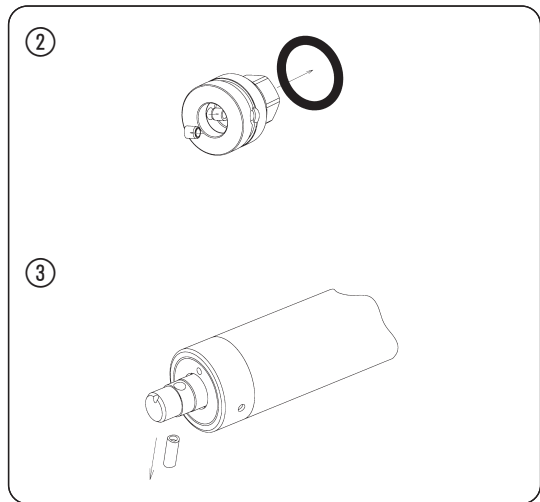

4. Antrieb in der gezeigten Position aufsetzen, neuen Sicherheits-Scherstift einsetzen und O-Ring aufziehen.

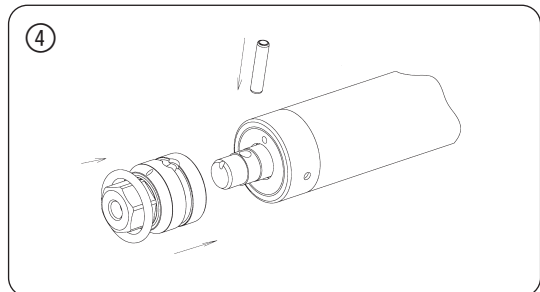

**Achtung:** Gesicherte Funktion ist ausschließlich bei Verwendung des Original HAZET Ersatzteilsatzes 4900-02A/3 gegeben!

## Arbeitshinweise

- MacPherson Federbein ausbauen.
- Spannplatten-Paar und Kunststoffeinlagen (siehe Tabelle Seite 13) passend zur Feder auswählen (siehe Zuordnungstabelle Seite 4 - 9), aufstecken und einrasten. Bei Verwendung des Federspanners ist zusätzlich die Reparaturanleitung des Fahrzeugherstellers zu beachten.

**Achtung:** Die Arretierbolzen  müssen vollständig eingerastet sein. Spannplatten 4 entsprechend der Federlänge auseinander fahren, um möglichst viele Windungen spannen zu können.

- HAZET Sicherheits-Federspanner mit der am Spannkörper angebrachten Aufnahmeleiste 10 im Schraubstock einspannen.

- Federbein zwischen Spannplatten einlegen und Spannvorgang beginnen.

**Achtung:** Aus Sicherheitsgründen auf exakten Sitz der Federwindung in der Spannplatte achten, weil es sonst zum Herausgleiten der Feder kommen kann. Dies kann wiederum zu erheblichen Körper-/Gesundheits- und Sachschäden führen.

- Mit einem Schlagschrauber oder geeignetem anderen Werkzeug Antrieb betätigen. Spannvorgang beenden, wenn das obere Federbeinlager entlastet ist.



Weiteres Spannen ist nicht zulässig, wenn sich die Windungen der Feder bereits berühren. Nicht weiter schrauben, wenn das obere oder untere Hubende erreicht ist.

- Alte Feder wieder entspannen oder durch eine neue Feder ersetzen:
  - Alte Feder durch Linksdrehen des Antriebes völlig entspannen.
  - Neue Feder in Federspanner einsetzen und spannen.

**Achtung:** Aus Sicherheitsgründen auf exakten Sitz der Federwindung in der Spannplatte achten.

- Federspanner mit Feder auf Federbein setzen. Dabei auf korrekte Lage der Feder achten. Federbeinlager montieren.
- Federspanner entspannen, bis dieser von der Feder genommen werden kann.

- Das Federbein kann jetzt wieder eingebaut werden.

- Der Federspanner darf im Einsatz nicht unbeaufsichtigt gelassen werden. Gespannte Federn sind schnellstmöglich wieder zu entspannen.

## Konische Feder

Eine Benutzung des Federspanners an konischen Federn ist nur zulässig, wenn die Federmittelachse und der Spannkörper 2 parallel sind. Benutzen Sie hierzu die geeigneten Spannplatten für konische Federn.

## Wartung und Pflege

- Gerät stets sauber halten. Keine entfettenden Mittel oder Wasser verwenden, da sonst die Selbstschmierung des Gerätes aufgehoben werden kann und Korrosion entsteht.

- Bei allen Rückfragen und Ersatzteilbestellungen bitte unbedingt die Artikelnummer des Gerätes angeben.

- Der Federspanner HAZET 4900-2A ist durch sein geschlossenes System wartungsfrei.

- Überprüfung und Reparatur ist ausschließlich durch den Hersteller vorzunehmen.



## For Your Safety



### Intended use

The spring vice is designed exclusively for tensioning and releasing coil springs in motor vehicles. Working safely with the spring vice is only possible if the operating instructions and safety information are read completely and the instructions contained therein are strictly followed. Failure to follow the instructions may result in serious or even fatal injury! If you have any further questions about the application and use of the spring vice, please contact our application technology department by telephone on +49 (0)2191/792-0 or in writing to info@hazet.de. HAZET-WERK Hermann Zerver GmbH & Co. KG will not be liable for any injuries to persons and damages to property that are caused by disregard of the operating instructions and safety information!

Spring vices may only be operated by trained and qualified personnel!

1. Check the inside spring vice for full functionality before each use. Do not use the inside spring vice if its functionality cannot be ensured or if damage is detected. If the spring vice is used despite its full functionality not being ensured, there is a risk of serious injury, health problems and material damage, and even fatal injury. Full functionality is guaranteed when:

- the O-ring fits evenly in the groove (the shear pin can slide out if the O-ring is missing);
- the locating strip is firmly seated on the tube;
- the locating strip is locked in place;
- the tool operates smoothly.

2. When tensioning the spring, make sure that the spring coils do not touch

each other, nor the two tensioning plates as shown in Fig. no. 4 (B), otherwise an overload may occur and cause the shear pin to break.

3. The spring centre line must always be parallel to the basic unit as shown in Fig. no. 2 (A). This applies especially to conical coil springs. Otherwise proper seating of the spring in the tensioning jaw is not guaranteed during the entire tensioning process.

4. Only suitable tensioning jaws may be used as shown in Fig. no. 4 (B). The spring according to Fig. no. 8 (D) must lie securely inside the outer rib according to Fig. no. 6 (D) and the safety lug according to Fig. no. 7 (D). Ensure that it is not possible for the spring as shown in Fig. no. 8 (D) to slip out of the tensioning jaws as shown in Fig. no. 4 (A).

5. Tensioning jaws may only be used or replaced in pairs. Before commencing tensioning, the pair of tensioning jaws must be fitted and latched in place as shown in Fig. no. 4 (A). Ensure that the locking bolts are fully engaged as shown in Fig. no. 3 (A). Otherwise the spring may jump out or the tensioning jaws may slide out. This would cause serious injury.

6. For safety reasons, any modification of the spring vice is strictly forbidden. In particular, do not replace the shear pin according to Fig. no. 5 (C) with a stronger shear pin, as then the overload protection is no longer ensured and the device may be overloaded.

7. Never pass on spring compressors to third parties without operating instructions!

8. Before and during the clamping operation and after each transport (change of location), the correct position of the spring must be checked in the device provided for this purpose.

### Tool Specifications

#### MacPherson Spring Vice

Basic appliance:	4900-2A
Max. tensioning force:	26 KN
Max. driving torque:	250 Nm
Max. length:	809 mm
Span:	309 mm
Weight w/o tensioning jaws:	8.4 kg
Replacement set:	4900-02A/3
Drive DIN 475 –	mm: s 27
	mm/rotation 3

Test temperature /  
Operational range  
room temperature      -20° up to +40° C

### Operating Controls

- 1 Drive nut
- 2 Compressing device
- 3 Locking pins
- 4 Tensioning jaws
- 5 Safety shearing pin
- 6 Outer rib
- 7 Safety ridge
- 8 Spring
- 9 Span
- 10 Location bar
- 11 O-Ring



## Basic Models and Accessories

### Tensioning jaws

Article No	d <sub>1</sub>	d <sub>2</sub>
4900-10	69.0	120.0
4900-11	107.0	151.0
4900-12	121.0	173.0
4900-13	146.0	207.5
4900-14A	81.0	114.0
4900-15A	111.5	152.5
4900-16	80.5	119.5
4900-17	124.0	175.0
4900-18	145.0	186.0
4900-19	80.5	119.5
4900-22	126.0	173.0
4900-23	152.0	207.5
4900-24	140.0	154.0
4900-25	47.0	77.0
4900-26	47.0	77.0
4900-30	80.0	146.0
4900-31	136.0	189.5
4900-33	136.0	189.5
4900-35	95.0	130.0

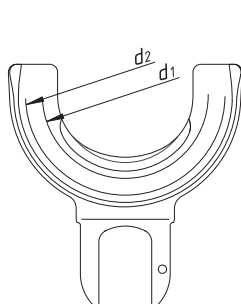

4900-10 up to 4900-23

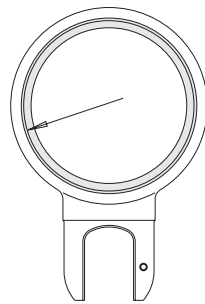

4900-24

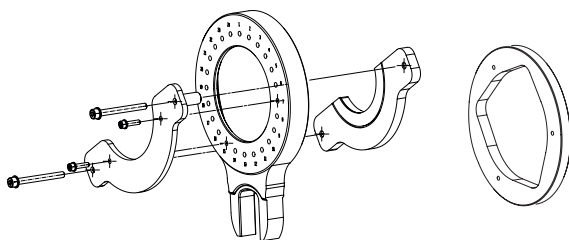

4900-39/11

4900-393 up to 4900-396

### Tensioning jaw with brake for MERCEDES-BENZ

4900-39/11

### Centring insert for MERCEDES-BENZ

4900-393	95.0	130.0
4900-394	95.0	130.0
4900-395	95.0	130.0
4900-396	95.0	130.0

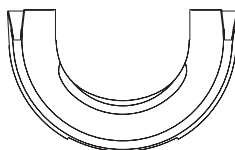

4900-100 up to 4900-231

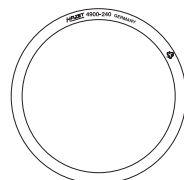

4900-240

### Plastic inserts

- 4900-100
- 4900-110
- 4900-120
- 4900-130
- 4900-180
- 4900-190
- 4900-220
- 4900-230
- 4900-231
- 4900-243
- 4900-310

### Safety shearing pin

Set of spare parts

4900-02A/3



4900-02A/3

## Safety Shearing Pin

The Safety Spring Vice is equipped with a safety shearing pin to protect the appliance against overcharge. An overcharge of the spindle can therefore be avoided.

1. Remove the drive from the spindle nut (with the aid of a screw M 10 x 30). Debur the shearing area if necessary.

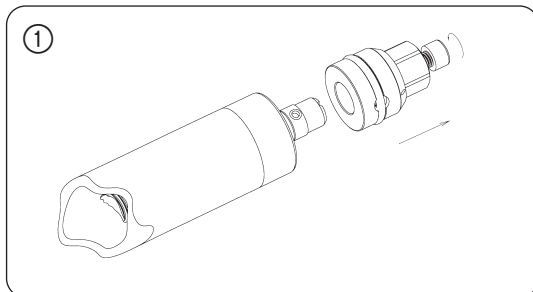

2. and 3. Remove the O-ring and the fragments of the shearing pin.

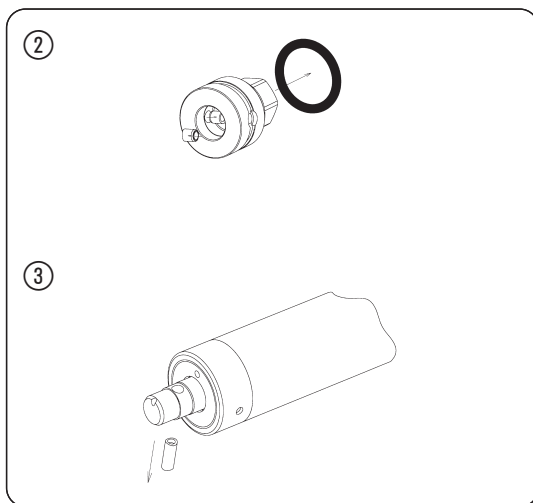

4. Replace the drive as shown in the illustration, insert a new safety shearing pin and put on the O-ring.

**Note:** Safe functioning can only be assured upon usage of the original HAZET replacement set 4900-02A/3!

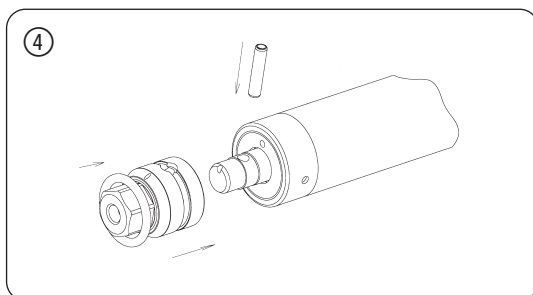

## Operating Instructions

- Remove the MacPherson strut unit.
- Select a pair of tensioning jaws and plastic spring protection inserts (see table page 17) to fit the spring (see table page 4 – 9), pin and latch. When using the spring vice, the vehicle manufacturer's repair instructions must also be observed.

**Note:** Please make certain the locking pins ③ are securely fastened. Drive the tensioning jaws 4 apart to match the length of the spring and to tension as many windings as possible.

- Fasten the location bar 10 of the HAZET Spring Vice into a suitable clamping device.
- Place the strut unit between the tensioning jaws and start tensioning.
- **Note:** For safety reasons assure the precise position of the spring windings in the tensioning jaws. Otherwise you risk a sliding out of the spring which cause severe damages to property and injuries to persons.
- Actuate the drive using an impact screwdriver or another suitable hand tool. Stop tensioning process when the upper strut bearing is released.



Further tensioning is not permitted when the spring windings are in contact with each other. Do not continue tensioning when the upper or lower stroke end of the piston is reached.

- Releasing the old spring or replacing with a new spring:
  - Release the old spring by turning the drive to the left.
  - Insert the new spring into the Spring Vice and start tensioning.

**Note:** For safety reasons assure the precise position of the spring windings in the tensioning jaws.

  - Place the Spring Vice with the spring inserted onto the strut unit. Take care that the position of the spring is correct. Mount the strut bearing.
  - Extend the Spring Vice until it can be taken off the spring.
- The strut unit can be remounted.
- Do not leave the spring vice unattended during use. Tensioned springs must be released as quickly as possible.

## Conical Spring

The use of the Spring Vice on conical springs is permitted only when the spring center axle and the compressing device 2 are parallel. For this purpose, use the tensioning jaws that are suitable for conical springs.

## Maintenance and Cleaning

- Always keep the Spring Vice clean. Do not use fat-free agents or water, the use of which could result in loss of self-lubrication of device and corrosion could set in.
- For questions and spare part orders please include the article number of the Spring Vice.
- The HAZET Spring Vice 4900-2A is maintenance-free due to its closed system.
- Examination and repair can only be carried out by the manufacturer.



## Utilisation conforme aux instructions

Le compresseur de ressort est exclusivement destiné à la compression et la détente de ressorts hélicoïdaux de suspension dans le secteur automobile. L'utilisation sans risque du compresseur de ressort peut uniquement être garantie par la lecture et la stricte observation des instructions contenues dans le mode d'emploi et les consignes de travail s'y rapportant. Le non-respect des instructions peut entraîner des blessures graves, même mortelles ! Pour toute autre question concernant le champ d'application et d'utilisation, veuillez contacter notre service technique d'application par téléphone au numéro suivant : 02191/792-0 ou par écrit à l'adresse : info@hazet.de. HAZET-WERK Hermann Zerver GmbH & Co. KG décline toute responsabilité quant aux dommages matériels et corporels qui feraient suite au non respect du mode d'emploi et des consignes de travail !

**!** Les compresseurs de ressort ne doivent être utilisés que par des spécialistes formés !

1. Vérifier le bon fonctionnement du compresseur de ressort avant toute utilisation. Si, lors de ce contrôle, un dysfonctionnement ou des dommages sont constatés, le compresseur de ressort ne doit pas être utilisé. Si le contrôle a montré un dysfonctionnement ou endommagement du compresseur et que le compresseur de ressort est quand même utilisé, il existe des risques de blessures ou de dommages matériels graves, voire de blessures mortelles. Le bon fonctionnement est assuré lorsque

- le joint torique est en contact uniforme avec la rainure (en l'absence de joint torique, la goupille de cisaillement peut glisser) ;
- la barre de préhension est fermement fixée sur le tube ;
- la barre de préhension est verrouillée ;
- l'appareil est facilement maniable.

2. Lors de la compression du ressort, il convient de s'assurer que les spires du ressort ne se touchent pas et que les deux coupelles conformément à la fig 4 (B) n'entrent pas en contact, sous peine de surcharge et donc d'une rupture de la goupille de cisaillement.

3. L'axe central du ressort doit toujours être parallèle à l'appareil de base conformément à la fig 2 (A). Cela vaut plus particulièrement pour les ressorts coniques. Dans le cas

contraire, la bonne assise du ressort dans la coupelle pendant toute la durée du processus de compression ne peut pas être garantie.

4. Seules des coupelles appropriées doivent être utilisées, conformément à la fig. 4 (B). Le ressort, conformément à la fig 8 (D), doit être bien positionné à l'intérieur de la nervure extérieure, conformément à la fig 6 (D), et de l'ergot de sécurité, conformément à la fig 7 (D). Il convient de s'assurer que le ressort, conformément à la fig. 8 (D), ne peut pas glisser hors des coupelles, conformément à la fig. 4 (A).

5. Les coupelles ne doivent être utilisées ou remplacées que par paires. Avant le début du serrage, la paire de coupelles doit être mise en place et enclenchée conformément à la fig. 4 (A). Il convient de s'assurer que les boulons d'arrêts sont entièrement enclenchés conformément à la fig. 3 (A). Dans le cas contraire, le ressort risque de sauter ou les coupelles de glisser. Il en résulte un risque de blessure.

6. Pour des raisons de sécurité, toute modification du compresseur de ressort est strictement interdite. Il est plus particulièrement interdit de remplacer la goupille de cisaillement, conformément à la fig. 5 (C), par une goupille de cisaillement plus forte sous peine d'inhiber la protection contre la surcharge et d'entraîner la surcharge de l'appareil.

7. Ne jamais remettre le compresseur de ressort à un tiers sans mode d'emploi !

8. Avant et pendant le processus de compression et après tout transport (déplacement), il convient de vérifier que le ressort est bien positionné dans le dispositif prévu à cet effet.

## Caractéristiques techniques

### Compresseur de ressort MacPherson

Réf. :	4900-2A
Force de serrage max. :	26 KN
Couple d'entraînement maxi. :	250 Nm
Longueur maxi. :	809 mm
Allongement :	309 mm
Poids sans coupelles :	8,4 kg
Pièces de rechange :	4900-02A/3
Entraînement DIN 475	mm : s 27 mm/tours 3

Température d'essai /  
plage d'utilisation  
température ambiante de -20° à +40° C

## Eléments de l'appareil

- |                            |                         |
|----------------------------|-------------------------|
| 1 Ecrou d'entraînement     | 7 Ergot de sécurité     |
| 2 Corps du compresseur     | 8 Ressort               |
| 3 Boulons de blocage       | 9 Allongement           |
| 4 Coupelles                | 10 Baguette de logement |
| 5 Goupille de cisaillement | 11 Joint torique        |
| 6 Nervure extérieure       |                         |

## Modèle de base et accessoires

### Supports de ressort

Réf.	d <sub>1</sub>	d <sub>2</sub>
4900-10	69,0	120,0
4900-11	107,0	151,0
4900-12	121,0	173,0
4900-13	146,0	207,5
4900-14A	81,0	114,0
4900-15A	111,5	152,5
4900-16	80,5	119,5
4900-17	124,0	175,0
4900-18	145,0	186,0
4900-19	80,5	119,5
4900-22	126,0	173,0
4900-23	152,0	207,5
4900-24	140,0	154,0
4900-25	47,0	77,0
4900-26	47,0	77,0
4900-30	80,0	146,0
4900-31	136,0	189,5
4900-33	136,0	189,5
4900-35	95,0	130,0

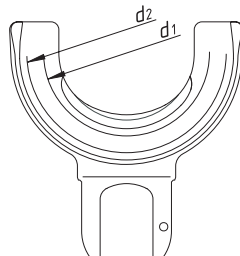

4900-10 à 4900-23

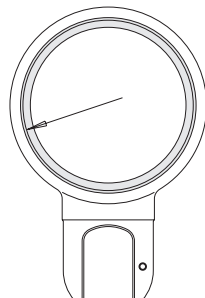

4900-24

### Jeu de coupelles avec frein pour MERCEDES-BENZ

4900-39/11

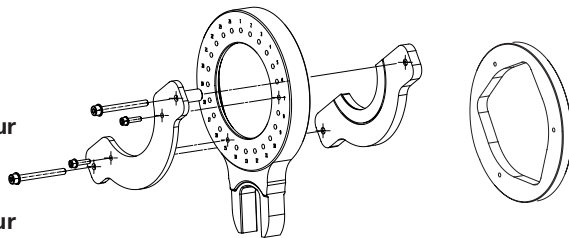

4900-39/11

4900-393 à 4900-396

### Bague de centrage pour MERCEDES-BENZ

4900-393	95,0	130,0
4900-394	95,0	130,0
4900-395	95,0	130,0
4900-396	95,0	130,0

### Protections en plastique

4900-100  
4900-110  
4900-120  
4900-130  
4900-180  
4900-190  
4900-220  
4900-230  
4900-231  
4900-243  
4900-310

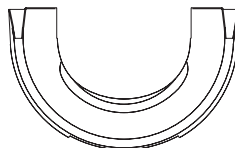

4900-100 à 4900-231

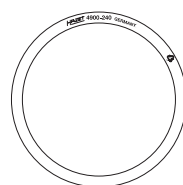

4900-240

### Goupille de cisaillement de sécurité Jeu de pièces de rechange

4900-02A/3



4900-02A/3

## Goupille de cisaillement de sécurité

Le compresseur de ressort est équipé d'une goupille de cisaillement de sécurité qui permet d'empêcher toute surcharge de la broche !

1. Démontez l'entraînement de la broche (à l'aide de l'outil, vis M 10 x 30). Si nécessaire, ébavurer les points de cisaillement.

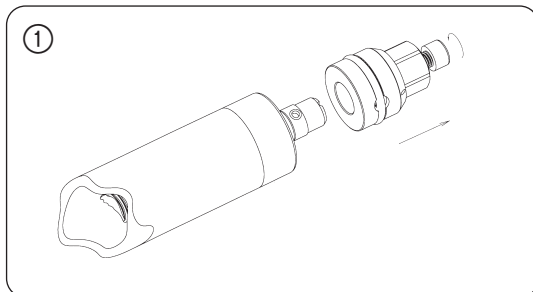

2. et 3. Retirez les résidus du joint torique et de la goupille de cisaillement.

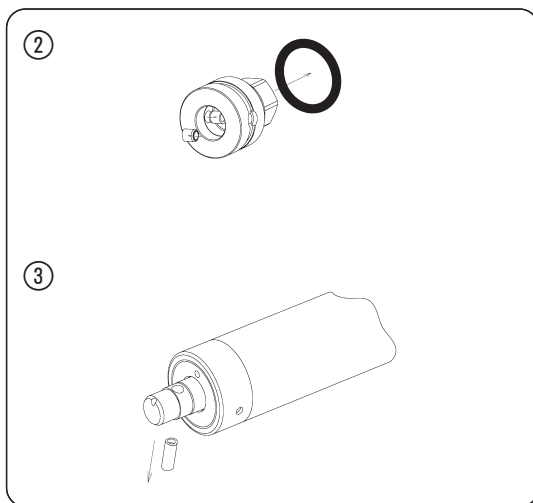

4. Placer l'entraînement dans la position indiquée et insérer la goupille de cisaillement et le joint torique neufs.

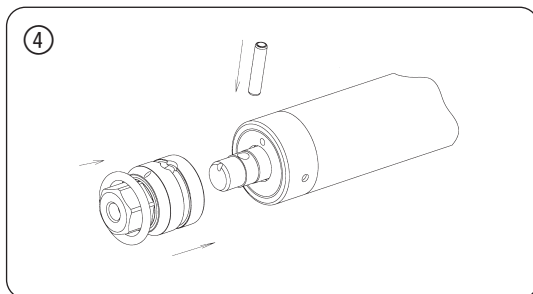

**Attention :** Un fonctionnement en toute sécurité n'est possible qu'avec le jeu de pièce de rechange HAZET d'origine 4900-02A/3!

## Instructions d'utilisation

- Démonter la jambe de force amortie Mac-Pherson.
- Sélectionner les coupelles et les protections en plastique (voir tableau à la page 21) conformément au ressort (voir tableau à la page 4 – 9) et les monter sur le compresseur de ressort. En cas d'utilisation du compresseur de ressort, il convient en outre de respecter les instructions de réparation du fabricant du véhicule.

**Attention :** Veiller au bon enclenchement des boulons de blocage ③. Ecarter les coupelles 4 conformément à la longueur du ressort afin de pouvoir compresser le plus de spires possible.

- Fixer la baguette de logement 10 du compresseur de ressort HAZET dans un dispositif de serrage approprié.
- Positionner la jambe de force amortie dans les coupelles et commencer à compresser.
- Actionner l'entraînement avec une visseuse à percussion ou un autre outil approprié jusqu'à ce que le palier de suspension supérieur se trouve libéré.



Une mise en tension supplémentaire n'est pas autorisée si les spires du ressort se touchent déjà. Ne continuez pas à visser lorsque la course maximale ou minimale de levage est atteinte.

- Faire dilater l'ancien ressort ou remplacer par un nouveau ressort:
  - Faire dilater complètement l'ancien ressort en tournant l'écrou d'entraînement vers la gauche.
  - Monter le nouveau ressort dans le compresseur de ressort et le compresser.
  - Monter le compresseur de ressort avec le ressort sur la jambe de force amortie. Veiller à la bonne position du ressort. Monter le palier de suspension.
  - Faire dilater le compresseur de ressort jusqu'à ce qu'il puisse être retiré du ressort.

**Attention :** Pour des raisons de sécurité veiller à une position correcte des spires dans les coupelles.

- Maintenant, il est possible de monter à nouveau la jambe de force amortie.
- Toujours surveiller le compresseur de ressort lors de son fonctionnement. Les ressorts tendus doivent être relâchés le plus rapidement possible.

## Ressort conique

Une utilisation du compresseur de ressort sur des ressorts coniques est seulement possible si l'axe central du ressort et le corps du compresseur sont parallèles l'un à l'autre. Pour cela, utiliser les coupelles appropriés aux ressorts coniques.

## Maintenance et nettoyage

- Maintenir toujours l'appareil propre. Ne pas utiliser de dégraissant ou d'eau qui pourrait gêner l'auto-lubrification de l'appareil et entraîner l'apparition de corrosion.
- Lors de toute demande d'information et de commande de pièce de rechange, il est nécessaire d'indiquer la réf. de l'appareil.
- Le compresseur de ressort HAZET 4900-2A est sans entretien, grâce au système fermé.
- Les contrôles et réparations doivent être effectués par le fabricant uniquement.



## Para su seguridad



### Uso conforme al previsto

El compresor y desmonta muelles sólo está previsto para el tensado y destensado de muelles helicoidales del chasis en el área del vehículo. El trabajo sin riesgos con el compresor y desmonta muelles solo se garantiza si ha leído las instrucciones e indicaciones de trabajo por completo y si sigue estrictamente dichas instrucciones. En caso de incumplimiento de las instrucciones existe riesgo de lesiones graves e incluso mortales. Si tiene más preguntas sobre el ámbito de aplicación y de uso, póngase en contacto por teléfono con nuestro departamento de tecnología aplicada en el número 02191/792-0 o por escrito en la dirección info@hazet.de. En caso de daños personales o materiales debidos al incumplimiento de las instrucciones y las indicaciones de trabajo, HAZET-WERK Hermann Zerver GmbH & Co. KG no asumirá ninguna responsabilidad.

**!** Únicamente el personal especializado está autorizado a manejar los compresores y desmonta muelles!

1. Antes de cada uso se deberá examinar el funcionamiento correcto del compresor y desmonta muelles. Si no puede garantizarse su funcionamiento o si se detectan daños después de realizar esta comprobación, no deberá utilizarse el compresor y desmonta muelles. Si se utiliza el compresor y desmonta muelles, a pesar de no funcionar perfectamente, existe el riesgo de que se produzcan graves daños materiales o lesiones físicas, incluso mortales. La herramienta funciona perfectamente cuando:

- el anillo de goma está posicionado en la ranura de forma uniforme (si falta el anillo de goma, el pasador cizallable puede salirse);
- la barra de alojamiento se asienta de forma firme sobre el tubo;
- la barra de alojamiento está bloqueada;
- la herramienta se mueve suavemente.

2. Al tensar el muelle, asegúrese de que las espiras de muelle no se toquen entre sí, ni tampoco las dos copelas según el n.º 4 de la figura (B), ya que, de lo contrario, el pasador cizallable podría sobrecargarse y romperse.

3. El eje central del muelle debe estar siempre paralelo al aparato básico según el n.º 2 de la figura (A). Eso se aplica

especialmente en caso de muelles cónicos. En caso contrario, no se garantiza el asiento perfecto del muelle en la copela durante todo el proceso de tensado.

4. Solo se deben utilizar copelas adecuadas conforme al n.º 4 de la figura (B). Según el n.º 8 de la figura (D), el muelle debe estar bien asentado dentro de la nervadura externa según el n.º 6 de la figura (D) y el saliente de seguridad según el n.º 7 de la figura (D). Es necesario asegurarse de que el muelle no pueda salirse según el n.º 8 de la figura (D) de las copelas según el n.º 4 de la figura (A).

5. Las copelas se deben montar o sustituir por pares. Antes del inicio del tensado, el par de copelas se insertará y enclavará según el n.º 4 de la figura (A). En esta operación hay que asegurarse de que el perno de bloqueo está perfectamente enclavado según el n.º 3 de la figura (A). En caso contrario, el muelle podría saltar o las copelas podrían salirse, lo que supone un peligro de lesiones.

6. Por motivos de seguridad, se prohíbe terminantemente modificar el compresor y desmonta muelles. En particular, no sustituya el pasador cizallable según el n.º 5 de la figura (C) por un pasador de cizallable más resistente, ya que entonces dejaría de estar garantizada la protección contra sobrecarga y la herramienta podría sobrecargarse.

7. No entregue nunca el compresor y desmonta muelles a terceros sin las instrucciones.

8. Antes y durante la operación de sujeción y después de cada transporte (cambio de ubicación), debe comprobarse la posición correcta del muelle en el dispositivo previsto a tal efecto.

## Características técnicas

### Compresor y desmonta muelles MacPherson

Nº de art.:	4900-2A
Fuerza de sujeción máx.:	26 KN
Par de apriete máx.:	250 Nm
Longitud máx.:	809 mm
Recorrido de tensado:	309 mm
Peso sin copelas:	8,4 kg
Piezas de repuesto:	4900-02A/3
Accionamiento DIN 475	mm: s 27 mm/revol. 3

Temperatura de comprobación /

rango de aplicación

temperatura ambiente de -20° a +40° C



## Componentes del aparato

- |                                     |                        |
|-------------------------------------|------------------------|
| 1 Tuerca de accionamiento           | 7 Orejeta de seguridad |
| 2 Aparato básico                    | 8 Muelle               |
| 3 Pasador de bloqueo                | 9 Recorrido de tensado |
| 4 Copelas                           | 10 Barra de fijación   |
| 5 Perno de cizalladura de seguridad | 11 Anillo toroidal     |
| 6 Nervio exterior                   |                        |

## Modelo base y accesorios

### Copelas

Nº de art.	d <sub>1</sub>	d <sub>2</sub>
4900-10	69,0	120,0
4900-11	107,0	151,0
4900-12	121,0	173,0
4900-13	146,0	207,5
4900-14A	81,0	114,0
4900-15A	111,5	152,5
4900-16	80,5	119,5
4900-17	124,0	175,0
4900-18	145,0	186,0
4900-19	80,5	119,5
4900-22	126,0	173,0
4900-23	152,0	207,5
4900-24	140,0	154,0
4900-25	47,0	77,0
4900-26	47,0	77,0
4900-30	80,0	146,0
4900-31	136,0	189,5
4900-33	136,0	189,5
4900-35	95,0	130,0

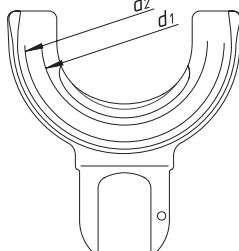

4900-10 à 4900-23

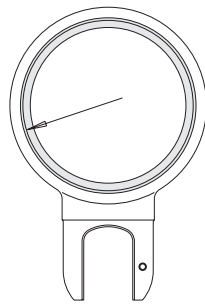

4900-24

### Copela con freno para MERCEDES-BENZ

4900-39/11

### Inserto de centrado para MERCEDES-BENZ

4900-393	95,0	130,0
4900-394	95,0	130,0
4900-395	95,0	130,0
4900-396	95,0	130,0

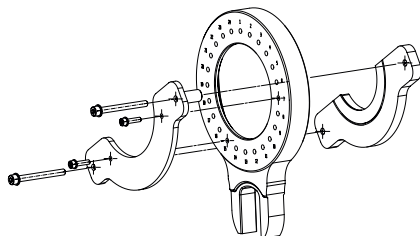

4900-39/11

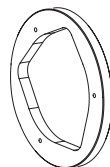

4900-393 à 4900-396

### Cubetas de plástico

4900-100  
4900-110  
4900-120  
4900-130  
4900-180  
4900-190  
4900-220  
4900-230  
4900-231  
4900-243  
4900-310

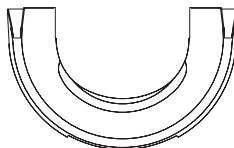

4900-100 à 4900-231

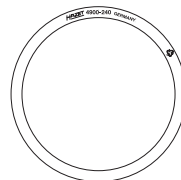

4900-240

### Perno de cizalladura de seguridad

Juego de piezas de repuesto

4900-02A/3



4900-02A/3

## Perno de cizalladura de seguridad

¡El compresor y desmonta muelles de seguridad está equipado con un perno de cizalladura de seguridad que impide una sobrecarga del husillo!

1. Separar el mecanismo de propulsión del husillo (utilizando como herramienta auxiliar un tornillo M 10 x 30). En caso necesario, eliminar las rebabas en las zonas de cizalladura.

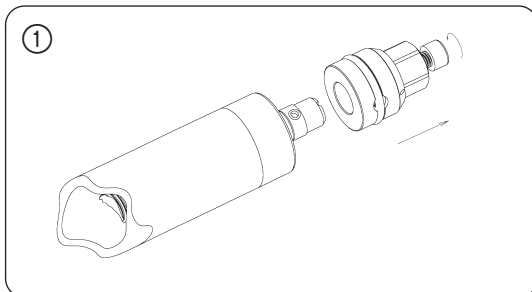

2. y 3. Retirar el anillo toroidal y los fragmentos del perno de cizalladura.

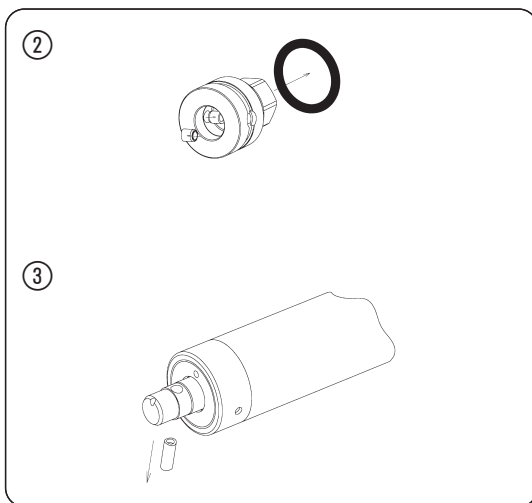

4. Colocar el mecanismo de propulsión en la posición mostrada, introducir el perno de cizalladura nuevo y encajar el anillo toroidal.

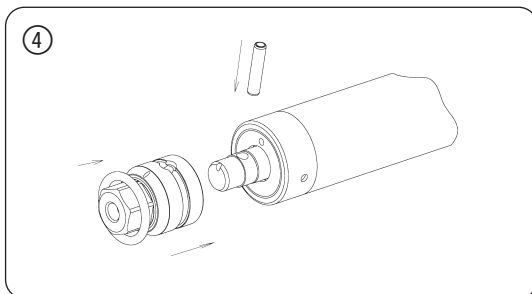

**Atención:** ¡El funcionamiento seguro sólo está garantizado si se emplea el juego de piezas de repuesto original de HAZET 4900-02A/3!

## Indicaciones de trabajo

- Desmontar el montante amortiguador Mac-Pherson.
- Seleccionar las copelas y las cubetas de protección (según la tabla en página 25) adecuadas para el muelle (según la tabla en página 4 – 9) y montarlas en el compresor y desmonta muelles. Al utilizar el compresor y desmonta muelles, también se deben seguir las instrucciones de reparación del fabricante del vehículo.

**Atención:** hay que asegurarse que los pasadores de bloqueo ③ hayan encajado completamente. Separar las copelas 4 de acuerdo a la longitud del muelle de forma que pueda comprimirse la mayor cantidad de espiras.

- Sujetar la barra de fijación 10 del compresor y desmonta muelles HAZET en un dispositivo.
- Introducir el montante amortiguador en las copelas y comenzar a tensar el muelle.

**Atención:** Por motivos de seguridad, prestar atención a que las espiras del muelle asienten correctamente dentro de las copelas.

- Activar el mecanismo de accionamiento con una llave de impacto o otra herramienta adecuada. Terminar tensar cuando el soporte amortiguador superior esté descargado.



No se permite seguir tensando si las espiras del muelle ya se tocan. No continúe atornillando cuando se alcance el final superior o inferior de carrera.

- Destensar el muelle antiguo o sustituirlo por uno nuevo:
  - Destensar completamente el muelle antiguo girando hacia la izquierda la tuerca de accionamiento.
  - Colocar el muelle nuevo en el compresor y desmonta muelles y tensarlo.

**Atención:** Por motivos de seguridad, prestar atención a que las espiras del muelle asienten correctamente dentro de las copelas.

  - Insertar el compresor con el muelle en el montante amortiguador, observando que la posición del muelle sea la correcta. Montar el soporte amortiguador.
  - Destensar suficientemente el compresor y desmonta muelles para poder retirarlo del muelle.

- A continuación puede montarse el montante amortiguador.
- El compresor y desmonta muelles no debe dejarse sin vigilancia durante su uso. Los muelles tensados se deben aflojar de nuevo lo más rápidamente posible.

## Muelles cónicos

La utilización del compresor y desmonta muelles en muelles cónicos es admisible únicamente si el eje central longitudinal del muelle queda paralelo al aparato básico 2. Además deben emplearse copelas adecuadas para muelles cónicos.

## Mantenimiento y conservación

- Mantener el aparato siempre limpio.
- Para cualquier consulta o al solicitar piezas de repuesto, es imprescindible indicar el nº de artículo del aparato.
- El compresor HAZET 4900-2A funciona con sistema cerrado, por lo que no necesita mantenimiento.
- La comprobación y la reparación sólo deberán ser realizadas por el fabricante.



## Utilizzo conforme alle prescrizioni

Il tendimolle è destinato esclusivamente al tensionamento e allo scarico delle molle elicoidali delle sospensioni negli autoveicoli. Solo una lettura completa delle istruzioni per l'uso e delle indicazioni operative nonché l'osservazione scrupolosa delle indicazioni ivi contenute garantiscono un uso sicuro del tendimolle. In caso di inosservanza delle indicazioni, sussiste il rischio di lesioni gravi o mortali! In caso di ulteriori domande sul campo di impiego e sull'applicazione, contattare telefonicamente il nostro reparto tecnico di applicazione al numero: 02191/792-0 o inviare una mail a [info@hazet.de](mailto:info@hazet.de). HAZET-WERK Hermann Zerver GmbH & Co. KG esclude qualsiasi sua responsabilità in caso di danni a persone o cose causati dalla mancata osservanza delle istruzioni per l'uso e delle indicazioni operative.

 I tendimolle devono essere utilizzati solo da personale specializzato formato!

1. Prima di ciascun utilizzo, controllare che il tendimolle funzioni perfettamente. Non utilizzare il tendimolle se dal controllo emerge che la funzionalità non è garantita oppure se vengono rilevati danni. Qualora il tendimolle venga utilizzato nonostante non ne sia stata attestata la perfetta funzionalità, si rischiano gravi lesioni personali (anche mortali) nonché ingenti danni materiali. La piena funzionalità è garantita se:

- l'o-ring aderisce uniformemente alla scanalatura (se l'o-ring manca, la spina di sicurezza può scivolare via);
- il listello di alloggiamento è fissato saldamente al tubo;
- il listello di alloggiamento è bloccato;
- il dispositivo può muoversi liberamente.

2. Durante il tensionamento della molla assicurarsi che le spire non si tocchino tra loro, neanche le due staffe come da Fig. 4 (B), poiché in caso contrario si può verificare un sovraccarico e quindi la rottura della spina di sicurezza.

3. L'asse centrale della molla deve essere sempre in posizione parallela rispetto al dispositivo principale come da Fig. 2 (A). Questo vale in particolare per le molle

coniche. In caso contrario non viene garantito il perfetto posizionamento della molla nel relativo supporto nel corso dell'intero processo di messa in tensione.

4. Si devono utilizzare esclusivamente supporti molla adeguati come da Fig. 4 (B). La molla come da Fig. 8 (D) deve essere disposta saldamente tra la nervatura esterna Fig. 6 (D) e il nasello di sicurezza Fig. 7 (D). Occorre accertarsi che la molla come da Fig. 8 (D) non possa scivolare via dal relativo supporto molla Fig. 4 (A).

5. I supporti molla devono essere montati o sostituiti esclusivamente in coppia. Prima di iniziare l'operazione di tensionamento, inserire e innestare in posizione la coppia di supporti molla come da Fig. 4 (A). Assicurarsi che i perni di arresto come da Fig. 3 (A), siano completamente innestati in posizione. In caso contrario la molla può saltare via oppure i supporti molla possono scivolare via. Ciò comporta il pericolo di lesioni.

6. Per motivi di sicurezza, è severamente vietato apportare modifiche al tendimolle. In particolare non sostituire la spina di sicurezza come da Fig. 5 (C), con una più resistente, poiché in tal caso non è più garantita la protezione atta ad impedire il sovraccarico del dispositivo.

7. Non cedere mai il tendimolle a terzi senza le istruzioni per l'uso!

8. Prima e durante la procedura di serraggio e dopo ciascun trasporto (spostamento), controllare il posizionamento corretto della molla nell'apposito dispositivo.

## Dati tecnici

### Tendimolle MacPherson

n. art.:	4900-2A
Forza di compressione max.:	26 KN
max. coppia di azionamento:	250 Nm
max. lunghezza:	809 mm
Corsa di compressione:	309 mm
Peso senza supporti della molla:	8,4 kg
Kit di parti di ricambio:	4900-02A/3
Azionamento DIN 475	mm: s 27 mm/rotazione 3
Temperatura di impiego / campo di impiego	
temperatura ambiente	da -20° a +40° C

## Elementi della macchina

- |                                                                                                                                                                                                                                  |                                                                                                                                                                                     |
|----------------------------------------------------------------------------------------------------------------------------------------------------------------------------------------------------------------------------------|-------------------------------------------------------------------------------------------------------------------------------------------------------------------------------------|
| <ul style="list-style-type: none"> <li>1 Dado di azionamento</li> <li>2 Dispositivo principale</li> <li>3 Perno di arresto</li> <li>4 Supporti della molla</li> <li>5 Spina di sicurezza</li> <li>6 Nervatura esterna</li> </ul> | <ul style="list-style-type: none"> <li>7 Nasello di sicurezza</li> <li>8 Molla</li> <li>9 Corsa di compressione</li> <li>10 Listello de alloggiamento</li> <li>11 O-ring</li> </ul> |
|----------------------------------------------------------------------------------------------------------------------------------------------------------------------------------------------------------------------------------|-------------------------------------------------------------------------------------------------------------------------------------------------------------------------------------|

## Modello base ed accessori

### Supporti della molla

n. art.	$d_1$	$d_2$
4900-10	69,0	120,0
4900-11	107,0	151,0
4900-12	121,0	173,0
4900-13	146,0	207,5
4900-14A	81,0	114,0
4900-15A	111,5	152,5
4900-16	80,5	119,5
4900-17	124,0	175,0
4900-18	145,0	186,0
4900-19	80,5	119,5
4900-22	126,0	173,0
4900-23	152,0	207,5
4900-24	140,0	154,0
4900-25	47,0	77,0
4900-26	47,0	77,0
4900-30	80,0	146,0
4900-31	136,0	189,5
4900-33	136,0	189,5
4900-35	95,0	130,0

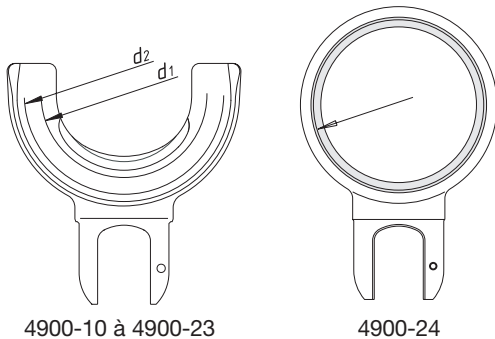

4900-10 à 4900-23

4900-24

### Ganascia con freno per MERCEDES-BENZ

4900-39/11

### Dispositivo di centraggio per MERCEDES-BENZ

4900-393	95,0	130,0
4900-394	95,0	130,0
4900-395	95,0	130,0
4900-396	95,0	130,0

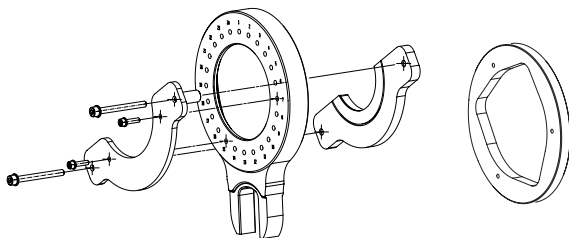

4900-39/11

4900-393 à 4900-396

### Spessori in plastica

- 4900-100
- 4900-110
- 4900-120
- 4900-130
- 4900-180
- 4900-190
- 4900-220
- 4900-230
- 4900-231
- 4900-243
- 4900-310

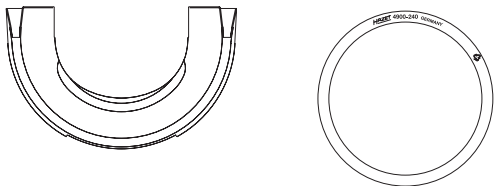

4900-100 à 4900-231

4900-240

### Spina di sicurezza Kit di parti di ricambio 4900-02A/3



4900-02A/3

## Spina di sicurezza

Il tendimolle di sicurezza è equipaggiato con una spina di sicurezza atta ad impedire il sovraccarico degli alberi filettati!

1. Staccare il meccanismo dagli alberi filettati (mediante l'attrezzo ausiliario, vite M 10 x 30). Se necessario, sbavare i punti di tranciatura.

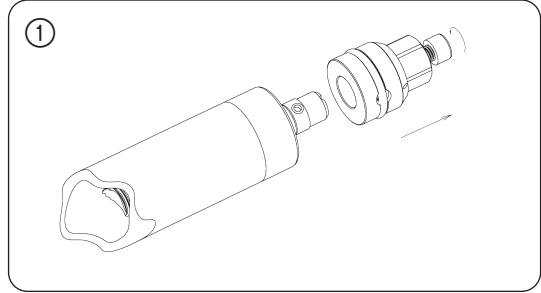

2. e 3. Rimuovere l'O-ring e i frammenti della spina di sicurezza.

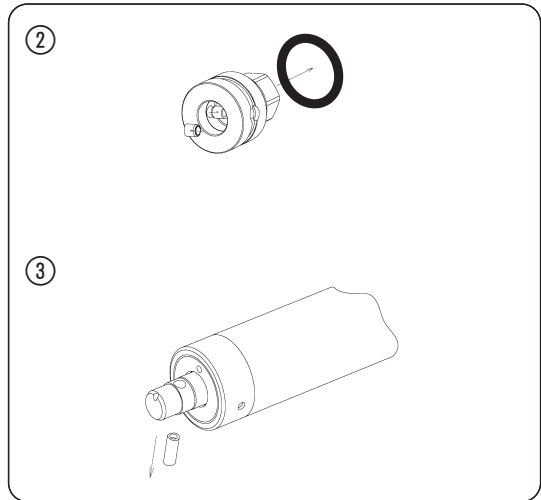

4. Collocare il meccanismo nella posizione indicata, inserire la nuova spina di sicurezza e sollevare l'O-ring.

**Attenzione:** Per garantire la funzionalità, utilizzare esclusivamente il kit di parti di ricambio originali HAZET 4900-02A/3!

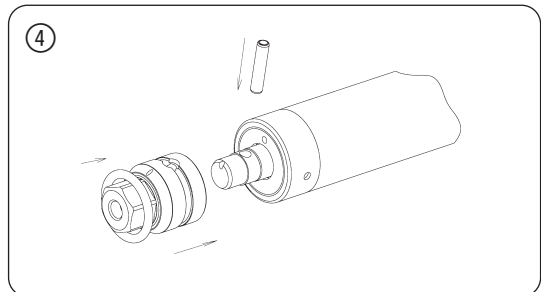

## Norme di lavoro

- Smontare l'ammortizzatore MacPherson.
- Selezionare la coppia di supporti e alloggiamenti in resina sintetica **4** (vedere la tabella a pagina 29) adatte per la molla (vedere la tabella a pagina 4 – 9), inserirle e bloccarle. Quando si utilizza il tendimolle, è necessario prestare attenzione alle istruzioni di riparazione del produttore del autoveicolo.

**Attenzione:** assicurarsi che i perni di arresto ③ siano completamente innestati in posizione. A seconda della lunghezza della molla, divaricare il supporto della molla **4** in modo da poter tendere il maggior numero possibile di spire.

- Serrare in morsa il tendimolle di sicurezza HAZET con il listello di alloggiamento **10** situato sul corpo di serraggio.
- Collocare il montante telescopico tra le supporti della molla e iniziare l'operazione di serraggio.

**Attenzione:** Per motivi di sicurezza, accertarsi che sia corretta la posizione delle spire della molla nel supporto della molla.

- Servendosi di un'avvitatrice ad impulsi o di un altro utensile apposito, azionare il meccanismo. Terminare l'operazione di serraggio quando il attacco degli ammortizzatore superiore non è più sotto carico.



Se le spire si toccano già non è consentito tensionare ulteriormente la molla. Non avvitare ulteriormente se è stata raggiunta la posizione di finecorsa superiore o inferiore.

- Allentare la vecchia molla oppure sostituirla con una nuova:
  - Allentare completamente la vecchia molla girando il dado di azionamento in senso antiorario.
  - Applicare la nuova molla nel tendimolle e tendere.

**Attenzione:** Per motivi di sicurezza, accertarsi che sia corretta la posizione delle spire della molla nel supporto della molla.

  - Applicare sulla gamba ammortizzatrice il tendimolle con la molla. Così facendo, attenzione che la posizione della molla sia corretta. Montare il attacco degli ammortizzatore.
  - Allentare il tendimolle fino a quando sarà possibile estrarlo dalla molla.

- L'ammortizzatore può dunque essere di nuovo montato.
- Il tendimolle non deve essere lasciato incustodito durante l'uso. Le molle in tensione devono essere rilasciate il più rapidamente possibile.

## Molle coniche

Il tendimolle può essere utilizzato con molle coniche soltanto se l'asse della molla ed il dispositivo principale **2** si trovano in posizione reciprocamente parallela. A tal fine, utilizzare le supporti della molla adatte per molle coniche.

## Manutenzione e assistenza

- Mantenere l'apparecchiatura sempre pulita.
- Per ogni tipo di domanda e per ordinare pezzi di ricambio, è estremamente necessario indicare sempre il codice di ordinazione della macchina.
- L'esecuzione chiusa del tendimolle HAZET 4900-2A li rende esente da manutenzione.
- Il controllo e la riparazione devono essere effettuati esclusivamente dal costruttore.

**HAZET**<sup>®</sup>

Das Werkzeug



**HAZET-WERK** Hermann Zerver GmbH & Co. KG

☑️ Güldenwerther Bahnhofstraße 25 - 29 · 42857 Remscheid · GERMANY

☒ 10 04 61 · 42804 Remscheid · GERMANY · ☎ +49 (0) 21 91/7 92-0

☎ +49 (0) 21 91/7 92-375 · [www.hazet.de](http://www.hazet.de) · ✉ info@hazet.de