



## LuK Service Info



# Part Nr: 335 0143 12 — 350mm TDCA – 10 spline

Manufacturer: FORD / FORD NEW HOLLAND

Info: Flywheel Information/  
Schwungradinformation/  
Informations de volant-moteur/  
Información del Volante-motor/  
Informazioni volano

Art.-Nr.: 335 0143 12





635 3082 09 = 135 0079 10 + 335 0143 12

635 3082 10 = 135 0079 10 + 335 0143 12 + 500 0933 00 + 410 0021 00

 Re-machine the flywheel inner recess to a diameter of  $174 \pm 0.3$  mm and a depth of  $4 \pm 0.3$  mm to avoid rivets contacting flywheel.

 Rectifique el hueco interior del volante motor con un diámetro de  $174 \pm 0,3$  mm y una profundidad de  $4 \pm 0.3$ mm con el fin de evitar que entre en contacto con los remaches.

 Die innere Eintiefung des Schwungrads muss auf einen Durchmesser von  $174 \pm 0,3$  mm und eine Tiefe von  $4 \pm 0.3$ mm bearbeitet werden, um zu verhindern, dass Niete mit dem Schwungrad in Berührung kommen.

 Rettificare nuovamente la cavità interna del volano a un diametro di  $174 \pm 0,3$  mm e una profondità di  $4 \pm 0.3$ mm per evitare che i rivetti tocchino il volano.

 Ré-usinez la cavité intérieure du volant-moteur de sorte à obtenir un diamètre de  $174 \pm 0,3$  mm et une profondeur de  $4 \pm 0.3$ mm pour éviter que les rivets ne touchent le volant-moteur.

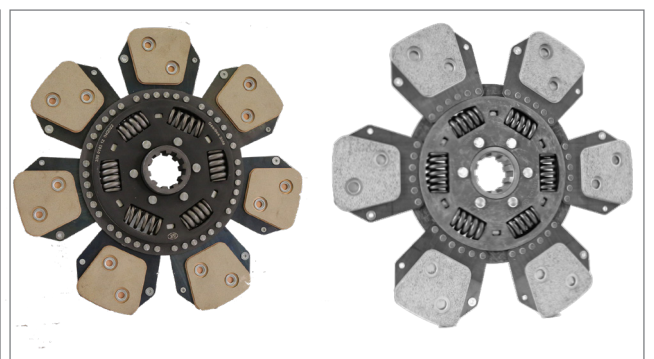
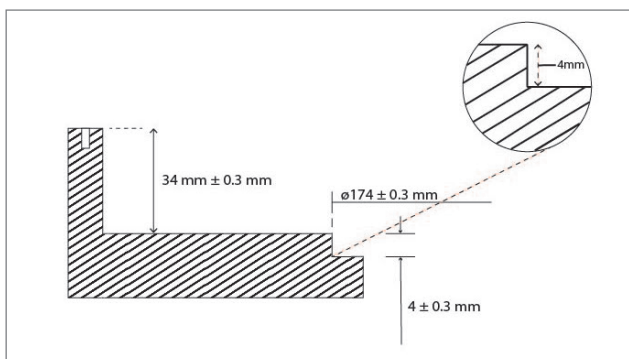

- For accurate model information please see LuK catalogue
- Die genaue Fahrzeugzuordnung entnehmen Sie bitte dem LuK-Katalog
- Pour plus d'information sur les applications veuillez vous référer au catalogue LuK
- Para obtener información sobre el modelo, rogamos consulte el catálogo de LuK

**You want more? We can help!**

Phone: +44 (0) 1432 264 264  
aftermarket.uk@schaeffler.com  
www.repexpert.co.uk

SCHAEFFLER  
**REP>XPERT**