

# Drosselklappe

# Throttle Valve

**Stellglied, elektromotorisch  
mit Sicherheitskontakt und Kupplung**

**Electromotive Actuator  
with safety contact and coupling**

**Abmaße / Dimensions (mm):**

Funktion nur in Verbindung mit  
entsprechendem Steuergerät.  
Function only with adequate control unit.

Nennspannung / Rated voltage: 12V

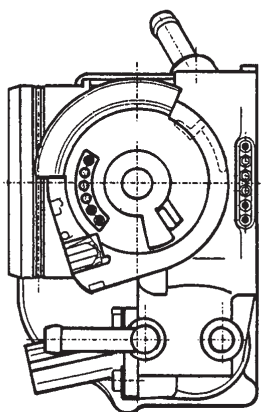
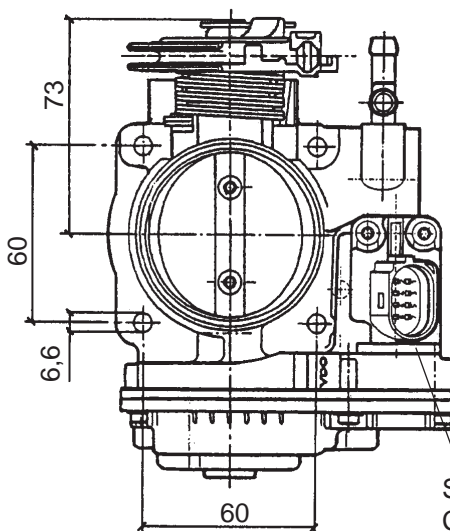
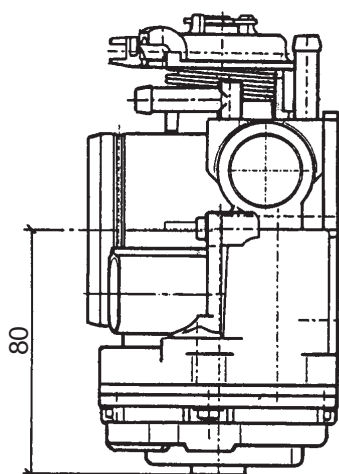
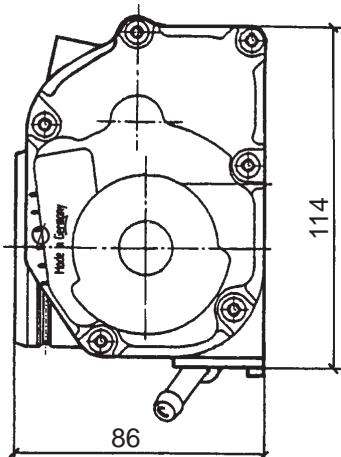

Pin-Belegung  
Pin allocation

1	IPA
2	MLK / Pot -
3	—
4	IPDK
5	Pot +
6	MLK +
7	Mot -
8	Mot +

Bestell-Nr. / Part No. **408-236-111-005Z**